

EN SKID PLATE INSTALLATION MANUAL

DE MONTAGEANLEITUNG FÜR UNTERBODEN SCHUTZSYSTEM



For: CFMOTO CFORCE 400L, 520L (2022-)

2K.8181.1



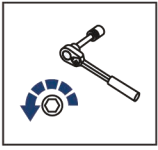

EN Regular fasteners
DE Normale Befestigung

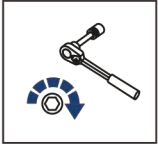

EN Regular fasteners
DE Normale Befestigung



EN Screw a several turns
DE Mit wenigen Umdrehungen befestigen



EN Loosen bolts
DE Bolzen lockern

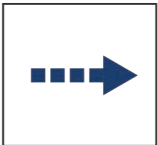

EN Movement Arrow
DE Bewegungsrichtung

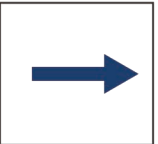





EN Location / Position Arrow
DE Anordnung / Positionsrichtung

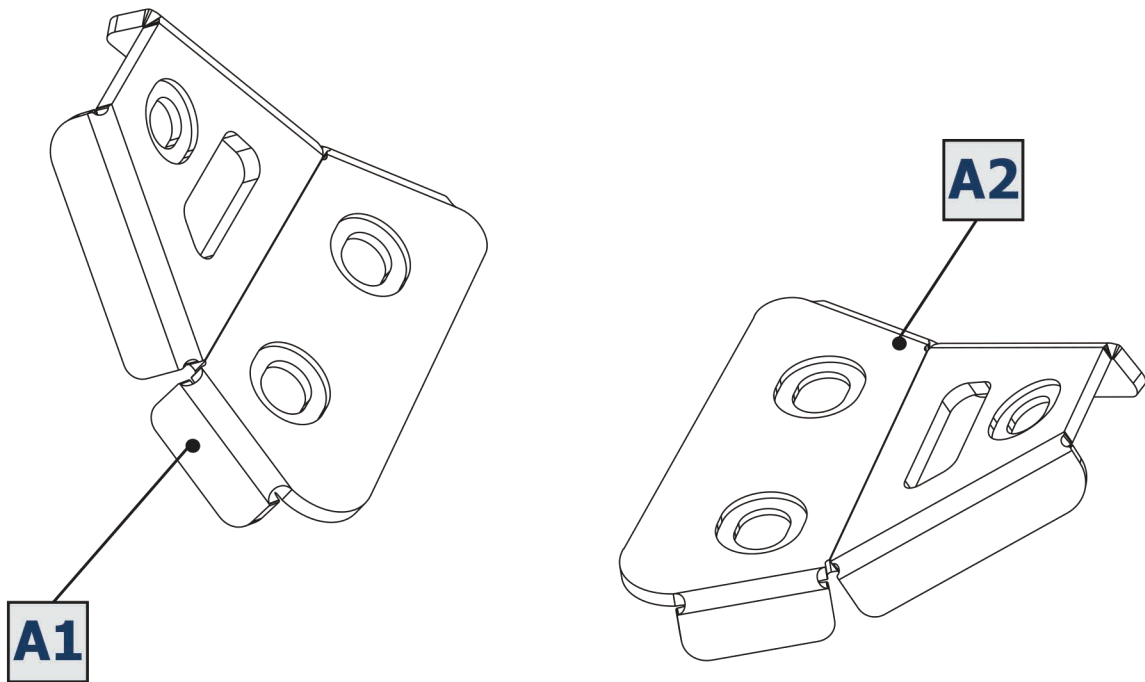
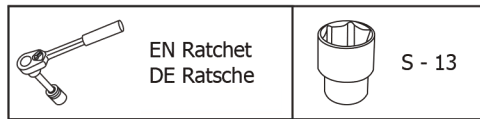

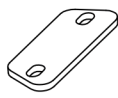
EN Screw Arrow
DE Drehrichtung

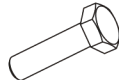
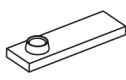

<p>1</p>  <p>x2</p>	<p>2</p>  <p>x2</p>	<p>3</p>  <p>M8x20 x2</p>	<p>4</p>  <p>M8x30 x4</p>	<p>5</p>  <p>M8x50/10 x4</p>	<p>6</p>  <p>ø8 x6</p>
---	---	---	---	--	--

