

EN **SKID PLATE INSTALLATION MANUAL**

DE **MONTAGEEINLEITUNG FÜR UNTERBODENSCHUTZSYSTEM**



For: Can-Am Outlander (2019-2022)

2K.8146.1



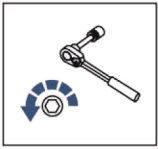

EN Regular fasteners
DE Originale montageile

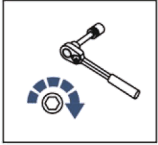

EN Regular fasteners
DE Originale montageile



EN Screw a several turns
DE Für wenigen Umdrehungen befestigen

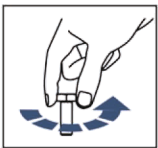

EN Loosen bolts
DE Bolzen lockern

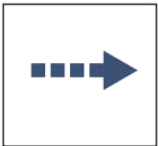

EN Movement Arrow
DE Bewegungsrichtung

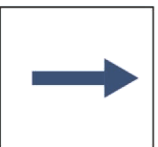

EN Location/Position Arrow
DE Anordnung/Positionsrichtung



EN Screw Arrow
DE Drehungsrichtung

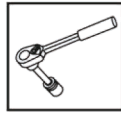

EN Ratchet
DE Ratsche

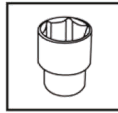

S - 10;
S - 13

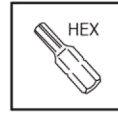

S - 4;
S - 5

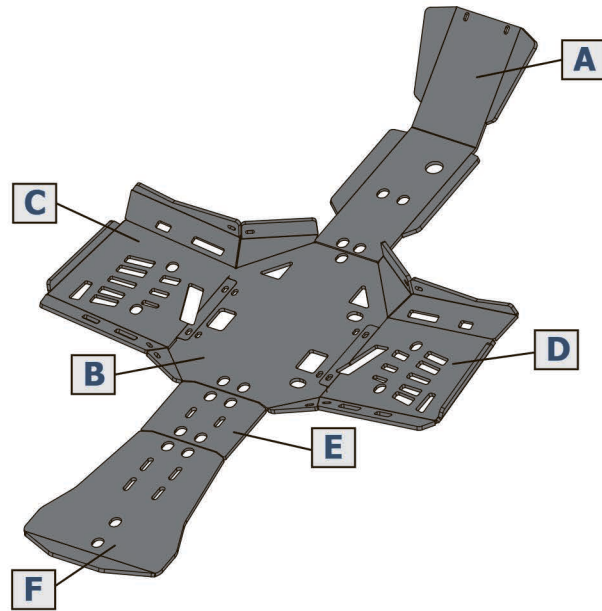

1 x1	2 x1	3 x1	4 x1	5 x2	6 x2
7 M8 x8	8 x2	9 x2	10 x1	11 x1	12 M8 x2
13 Ø8 x18	14 Ø8 x8	15 Ø8 x19	16 x2	17 M8x20 x8	18 M8x25 x8
19 M8x35 x11	20 M8x25 x18				

