

EN REAR CV GUARDS INSTALLATION MANUAL

DE MONTAGEEINLEITUNG FÜR SEITENSTUFENSCHUTZ



**For: CFMOTO CForce 400L, 400S / 520L,
520S (2022-)**

2444.8182.1

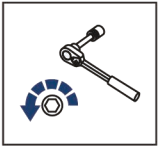

EN Regular fasteners
DE Normale Befestigung

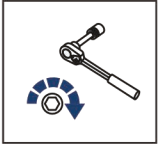

EN Regular fasteners
DE Normale Befestigung



EN Screw a several turns
DE Mit wenigen Umdrehungen befestigen



EN Loosen bolts
DE Bolzen lockern

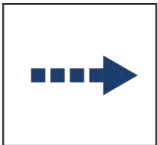

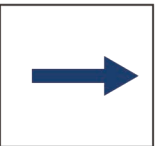

EN Movement Arrow
DE Bewegungsrichtung





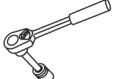

EN Location / Position Arrow
DE Anordnung / Positionsrichtung

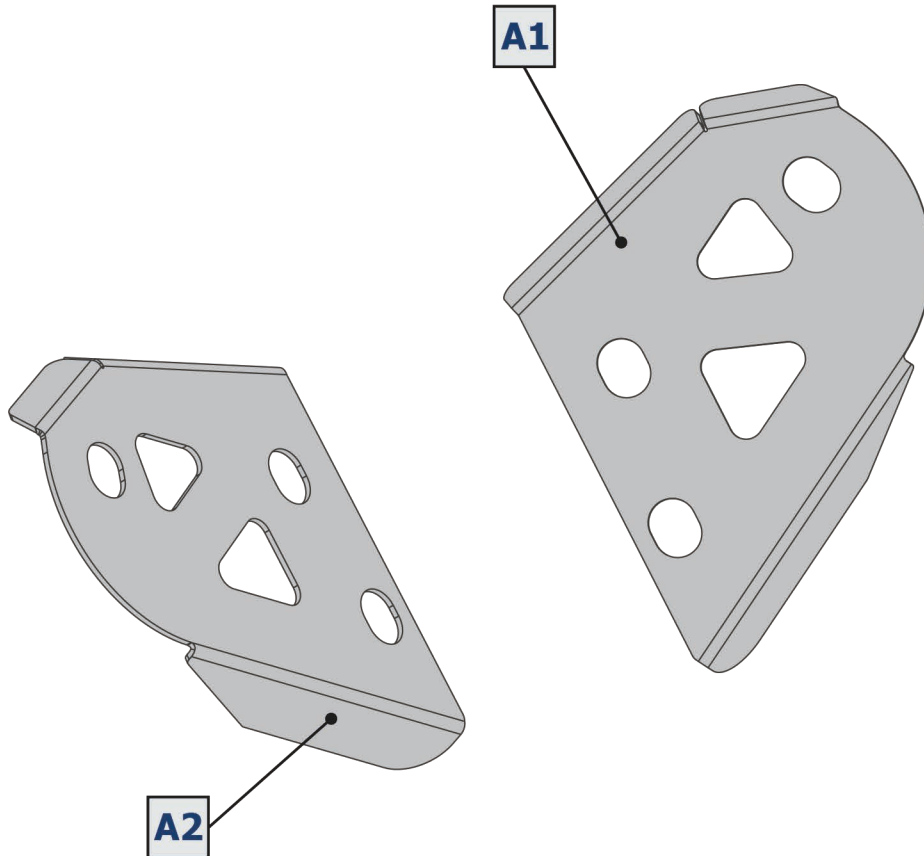

EN Screw Arrow
DE Drehrichtung

 <p>EN Ratchet DE Ratsche</p>	 <p>S - 10 S - 13 S - 17</p>	 <p>HEX S - 4 S - 5</p>
--------------------------------------------------------------------------------------------------------------------	-----------------------------------------------------------------------------------------------------------------------	-------------------------------------------------------------------------------------------------------------------



<p>1</p>  <p>x6</p>	<p>2</p>  <p>M8x20</p> <p>x6</p>	<p>3</p>  <p>ø8</p> <p>x6</p>
---------------------------------------------------------------------------------------------------------------	----------------------------------------------------------------------------------------------------------------------------	-------------------------------------------------------------------------------------------------------------------------

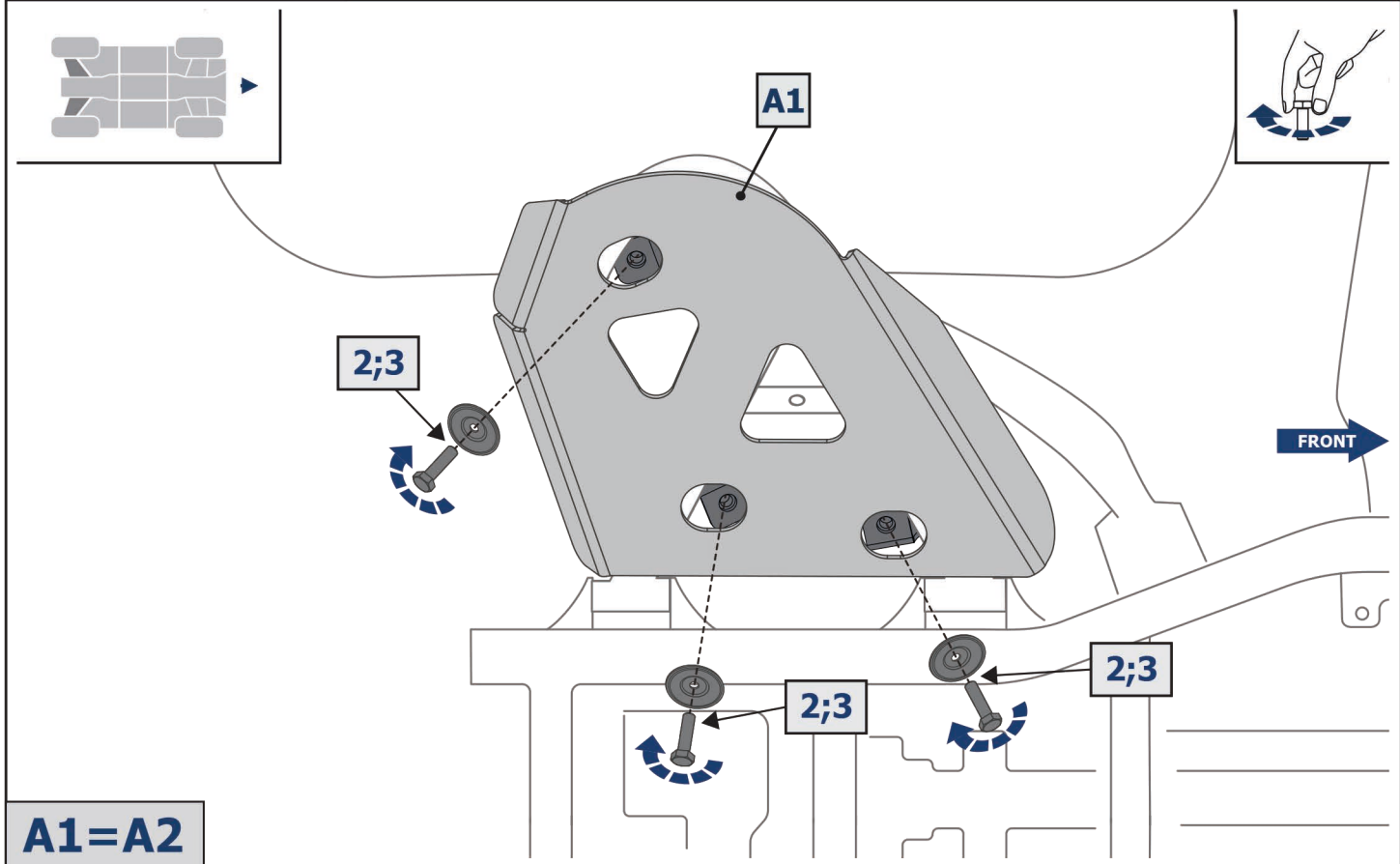
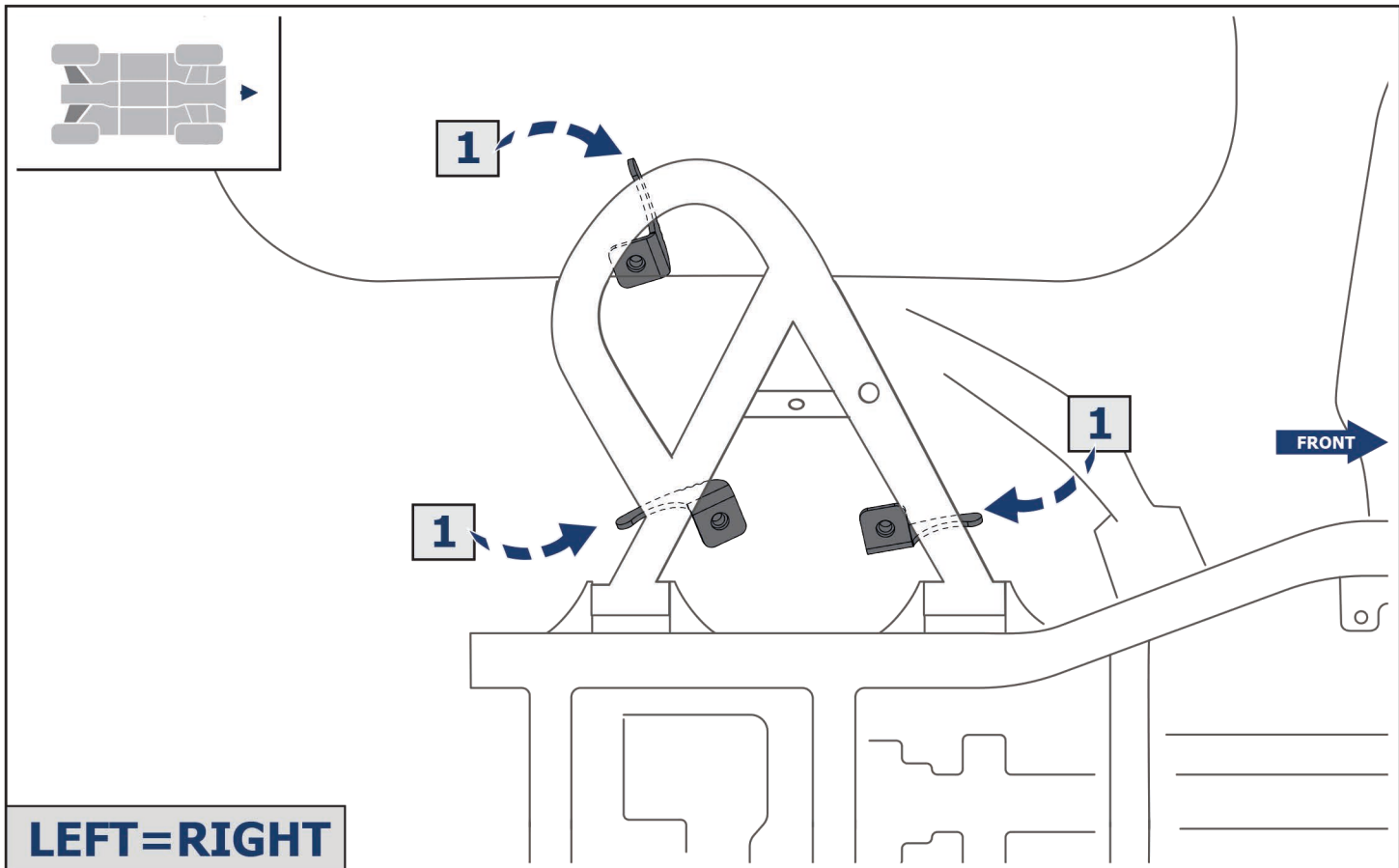

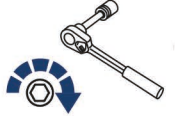
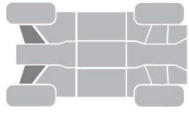

M8=24.0 Nm

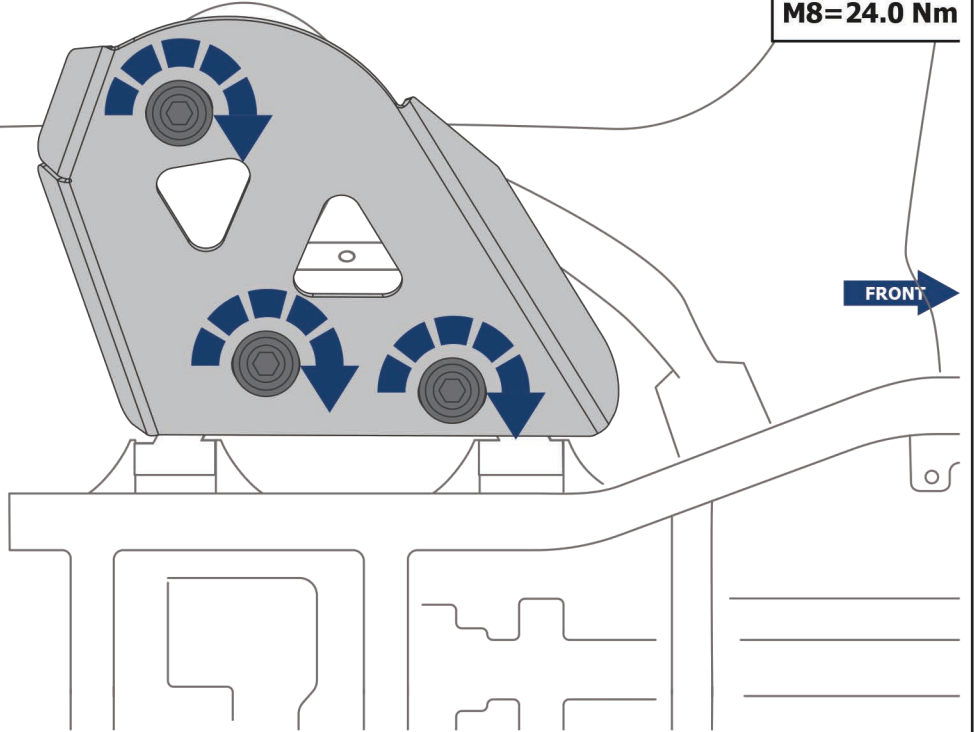

A1=A2