

EN DOORS KIT INSTALLATION MANUAL

DE MONTAGESATZ FÜR TÜREN KIT MONTAGEANLEITUNG



For: CFMOTO UForce 600 (2022-)

2444.8168.1

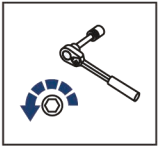

EN Regular fasteners
DE Normale Befestigung

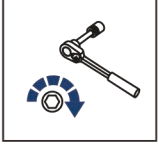

EN Regular fasteners
DE Normale Befestigung



EN Screw a several turns
DE Mit wenigen Umdrehungen befestigen



EN Loosen bolts
DE Bolzen lockern

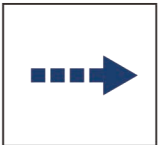

EN Movement Arrow
DE Bewegungsrichtung

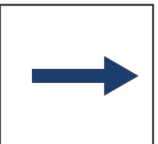







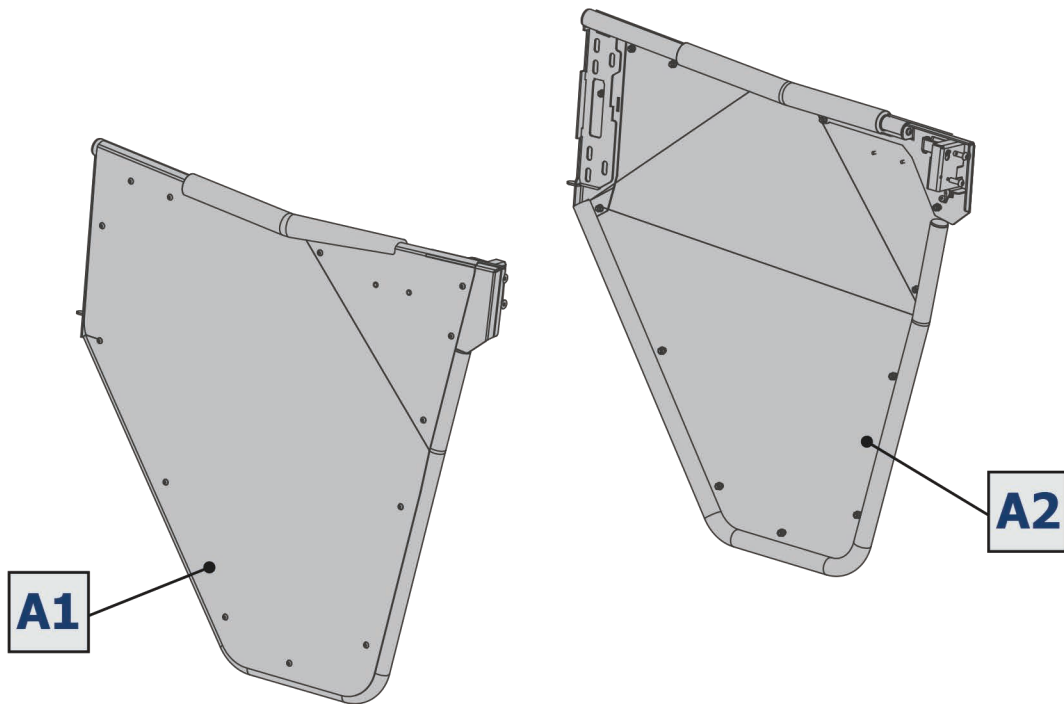

EN Location / Position Arrow
DE Anordnung / Positionsrichtung

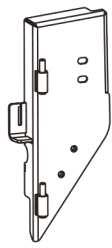
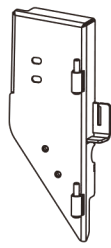
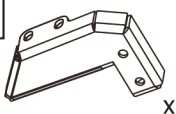
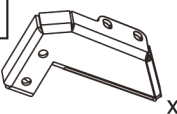
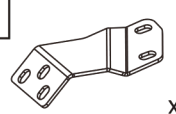
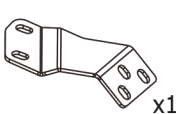
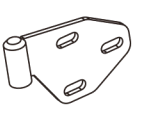
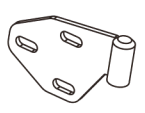
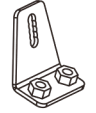
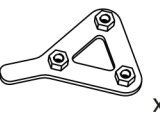

EN Screw Arrow
DE Drehrichtung

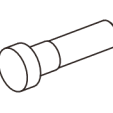
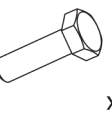
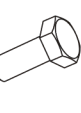
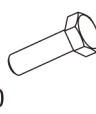
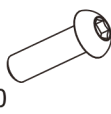
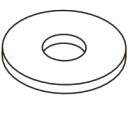
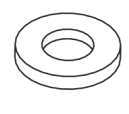
	EN Ratchet DE Ratsche		S - 10 S - 13 S - 17		HEX S - 6
---	--------------------------	---	----------------------------	--	--------------

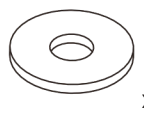

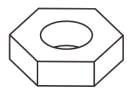
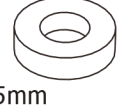
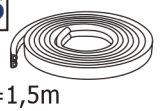
1  x1	2  x1	3  x1	4  x1	5  x1	6  x1
7  x2	8  x2	9  x2	10  x4		
11  x8	12  x2	13  x4	14  x2	15  M8x20 x14	16  M8x16 x6
17  M6x20 x12	18  M8x20 x8	19  ø8 x20	20  ø8 x10	21  ø8 x2	22  ø6 x12
23  ø6 x12	24  M10 x4	25  ø8 5mm x4	26  L=1,5m x1		

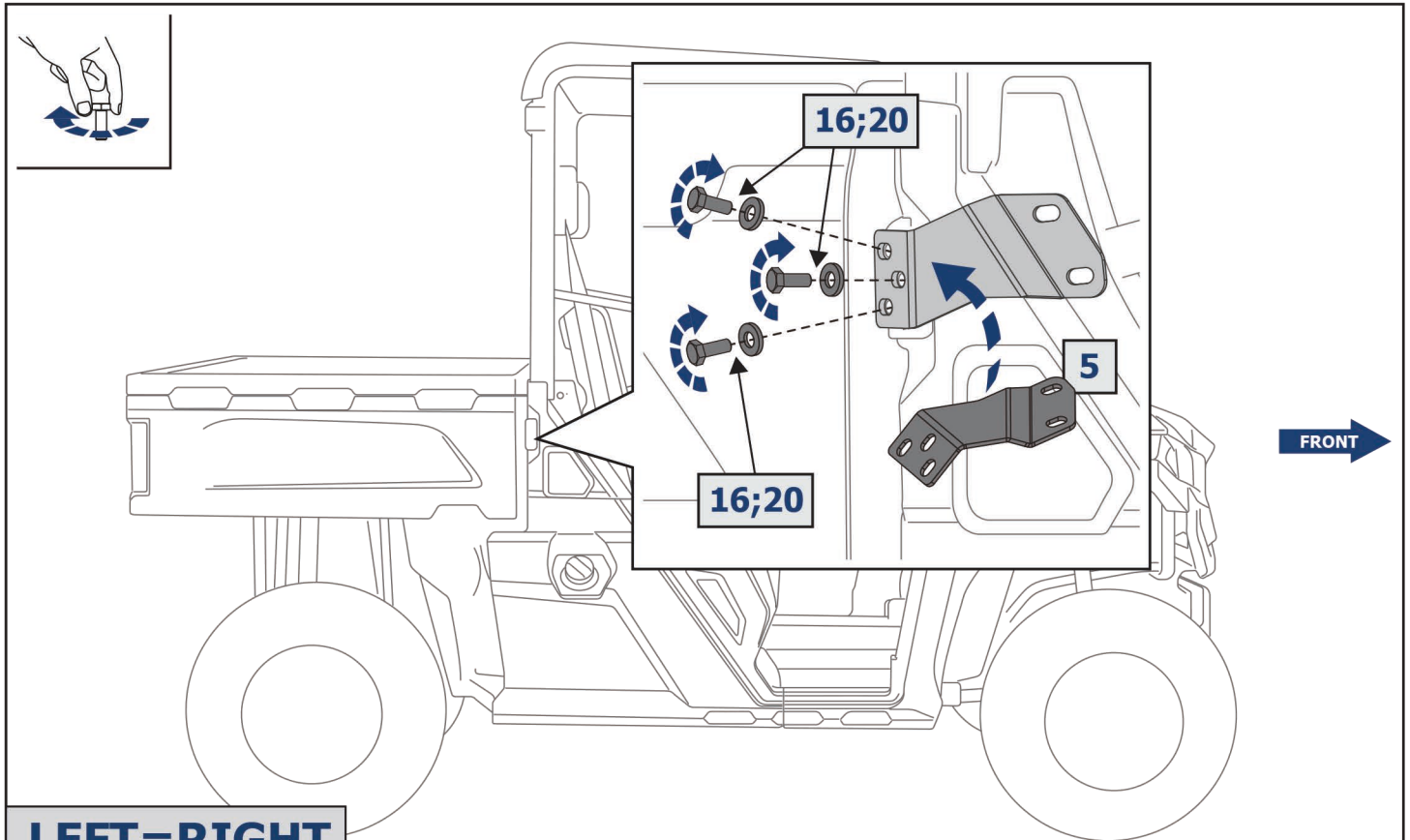

LEFT=RIGHT

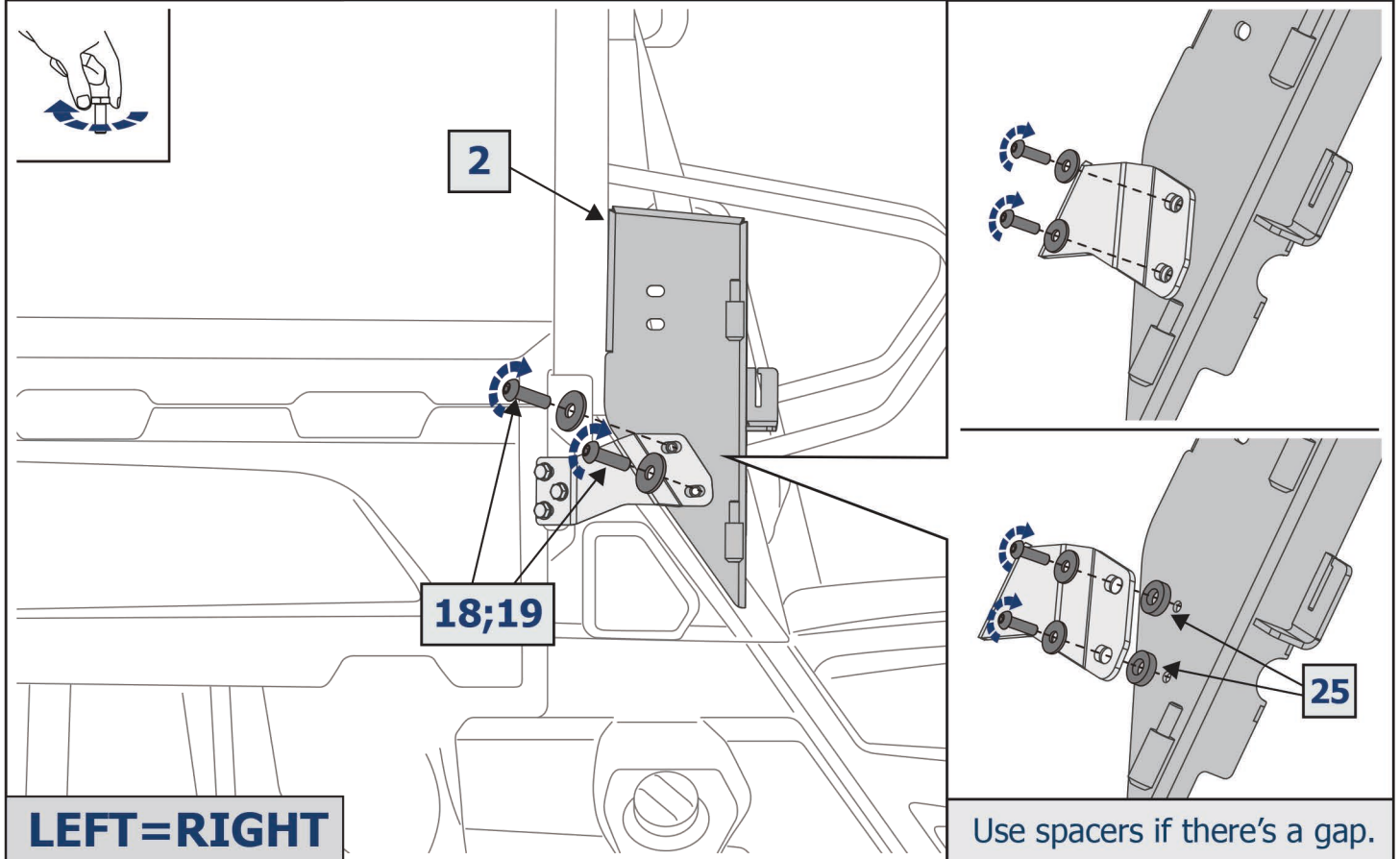

LEFT=RIGHT

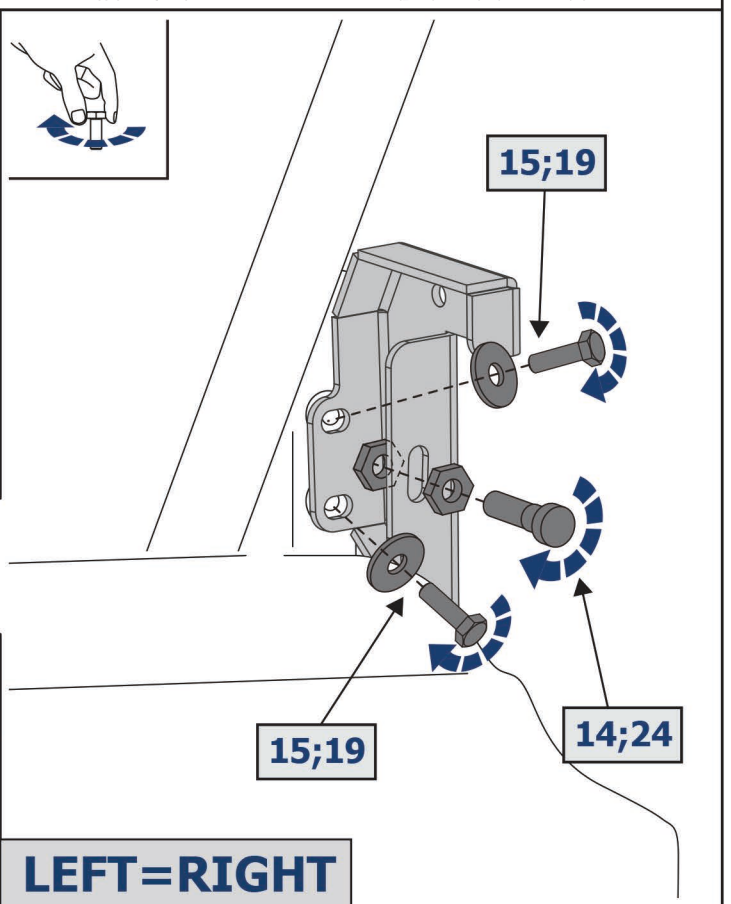
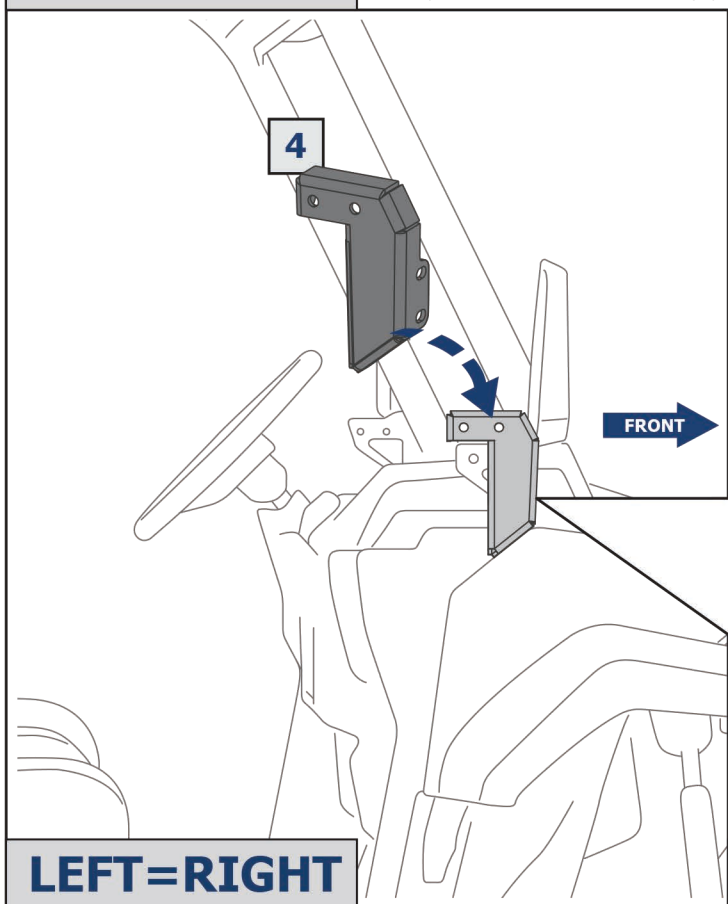
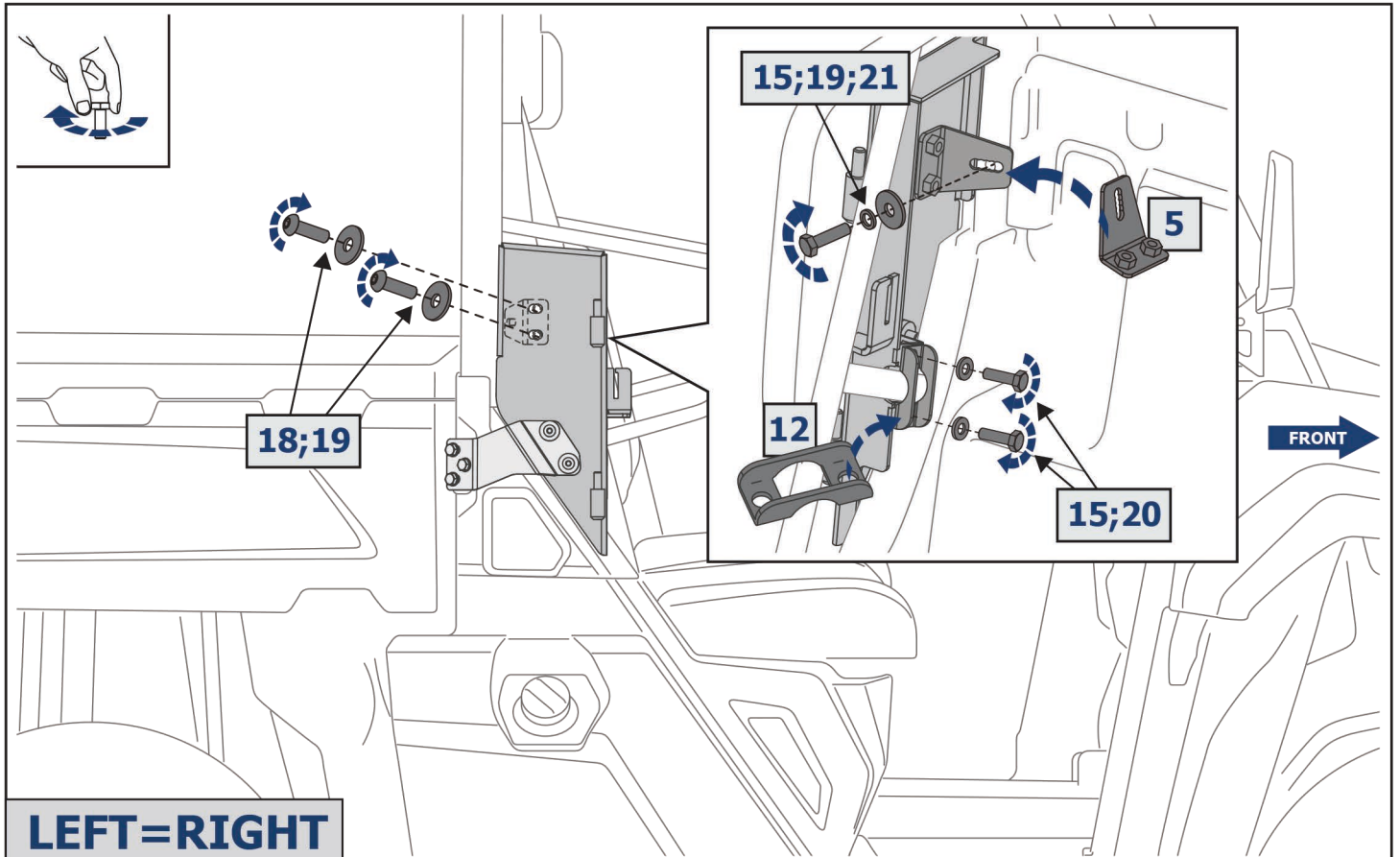

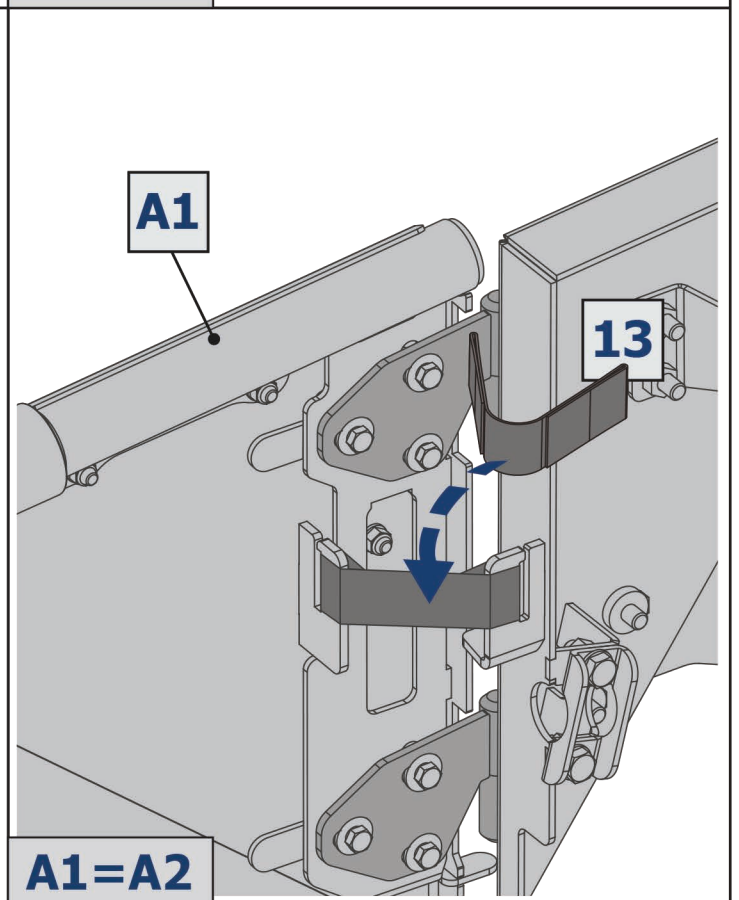
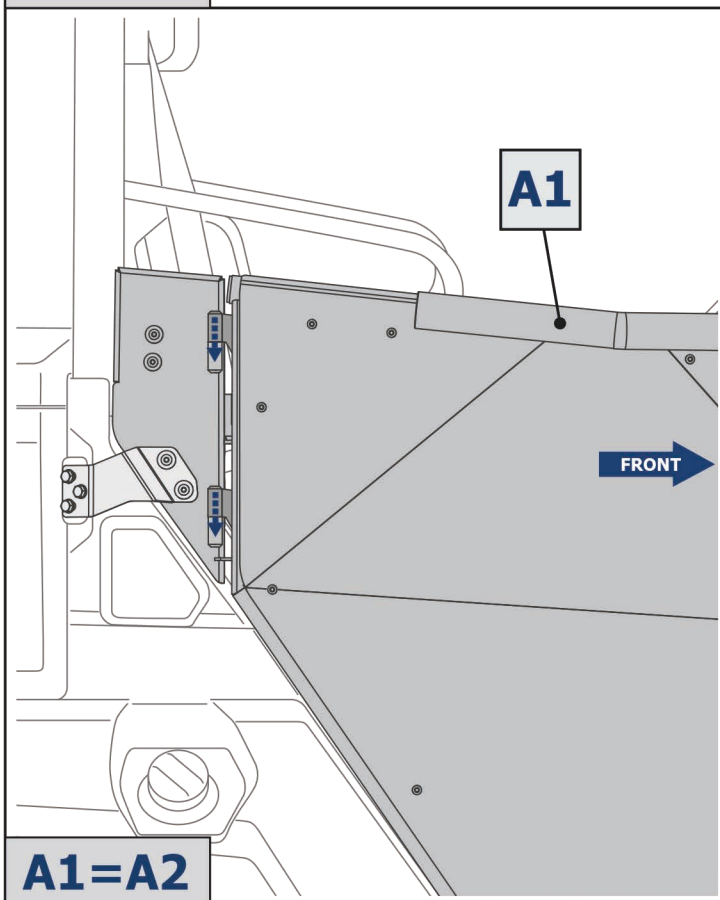
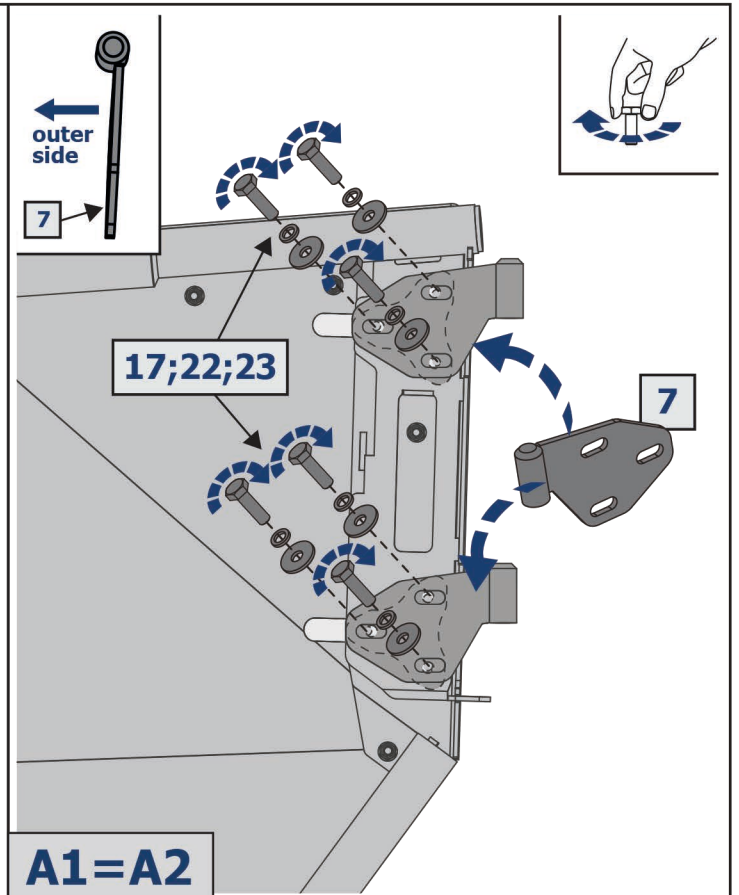
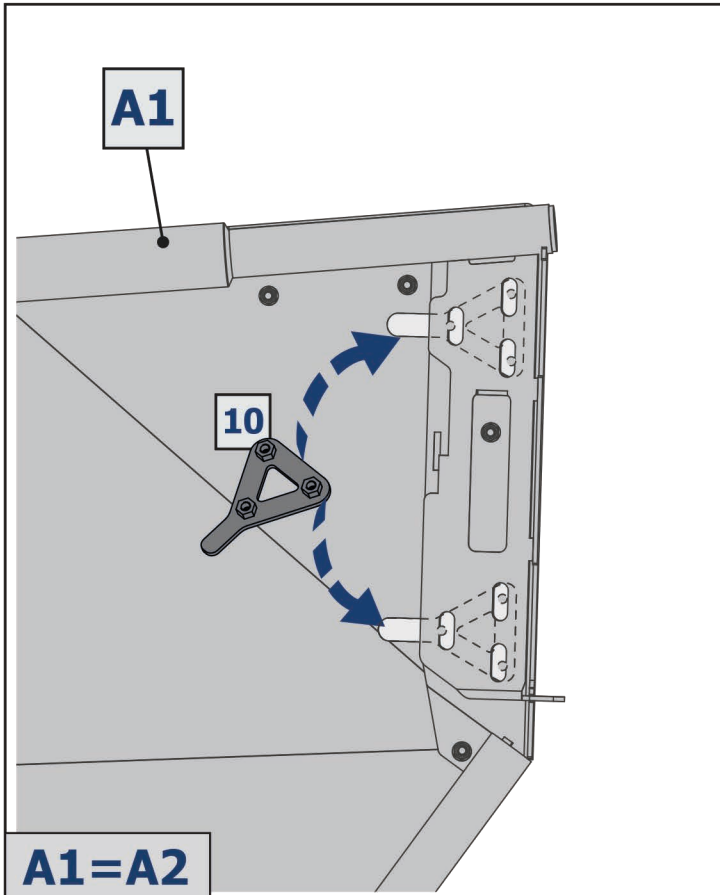

GLUING THE SEALANT (OPTIONAL)

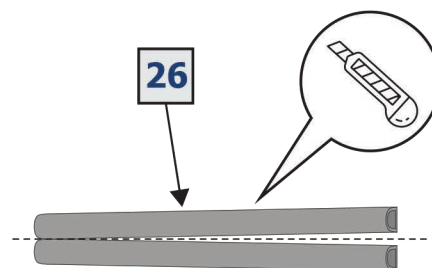
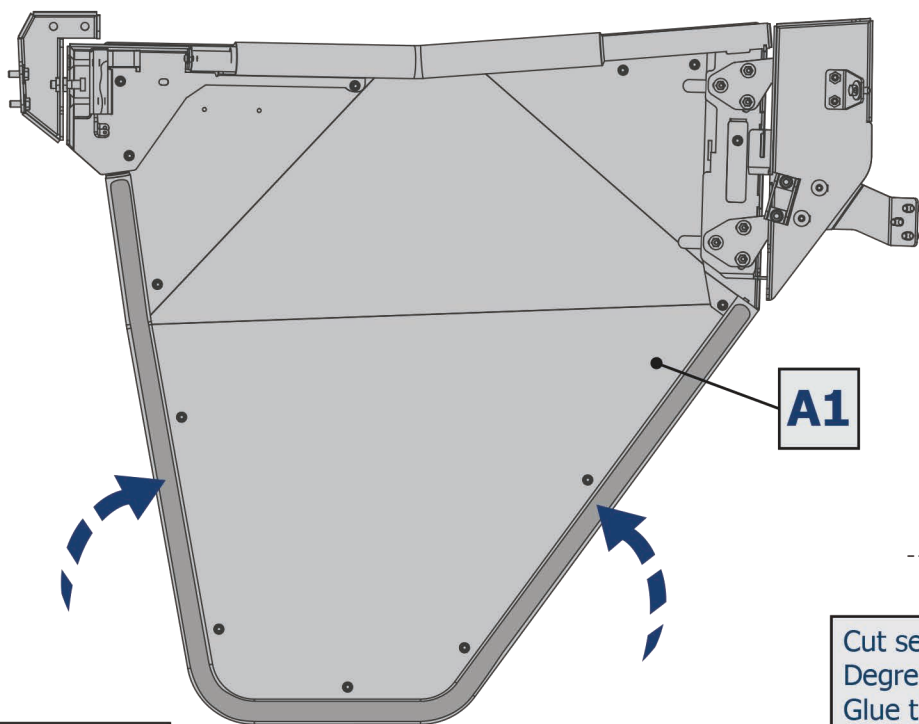

Cut sealant in half.
Degrease the specified door surfaces.
Glue the sealant to the indicated places.

A1=A2

DOOR POSITION ADJUSTMENT

