

EN **SKID PLATE INSTALLATION MANUAL**

DE **MONTAGEEINLEITUNG FÜR UNTERBODENSCHUTZSYSTEM**



**For: CF Moto UTV CF800-U8W (2014- )**

2444.8144.1



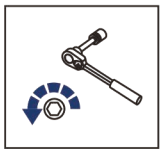

EN Regular fasteners  
DE Originale montageile

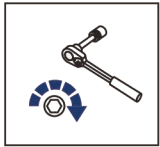

EN Regular fasteners  
DE Originale montageile



EN Screw a several turns  
DE Für wenigen Umdrehungen befestigen



EN Loosen bolts  
DE Bolzen lockern

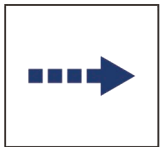

EN Movement Arrow  
DE Bewegungsrichtung

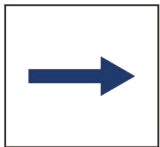

EN Location/Position Arrow  
DE Anordnung/Positionsrichtung



EN Screw Arrow  
DE Drehungsrichtung



EN Ratchet  
DE Ratsche



S - 10;  
S - 13



EN Office Knife  
DE Büromesser





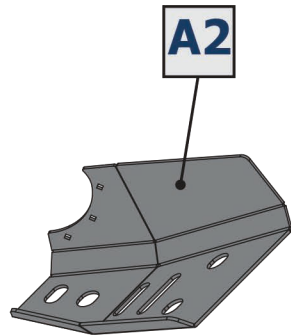



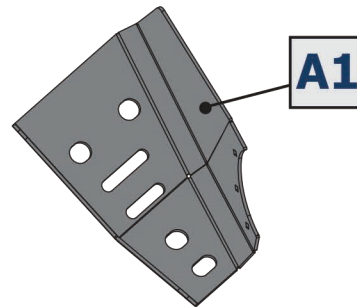

HEX  
S - 5  
S - 4



A2



A1

<p><b>1</b></p>  <p>x1</p>	<p><b>2</b></p>  <p>x1</p>	<p><b>3</b></p>  <p>Ø6 x6</p>	<p><b>4</b></p>  <p>M6x16 x6</p>	<p><b>5</b></p>  <p>M6x25 x6</p>	<p><b>6</b></p>  <p>M6 x6</p>
<p><b>7</b></p>  <p>Ø6 x6</p>	<p><b>8</b></p>  <p>Ø6 x6</p>				

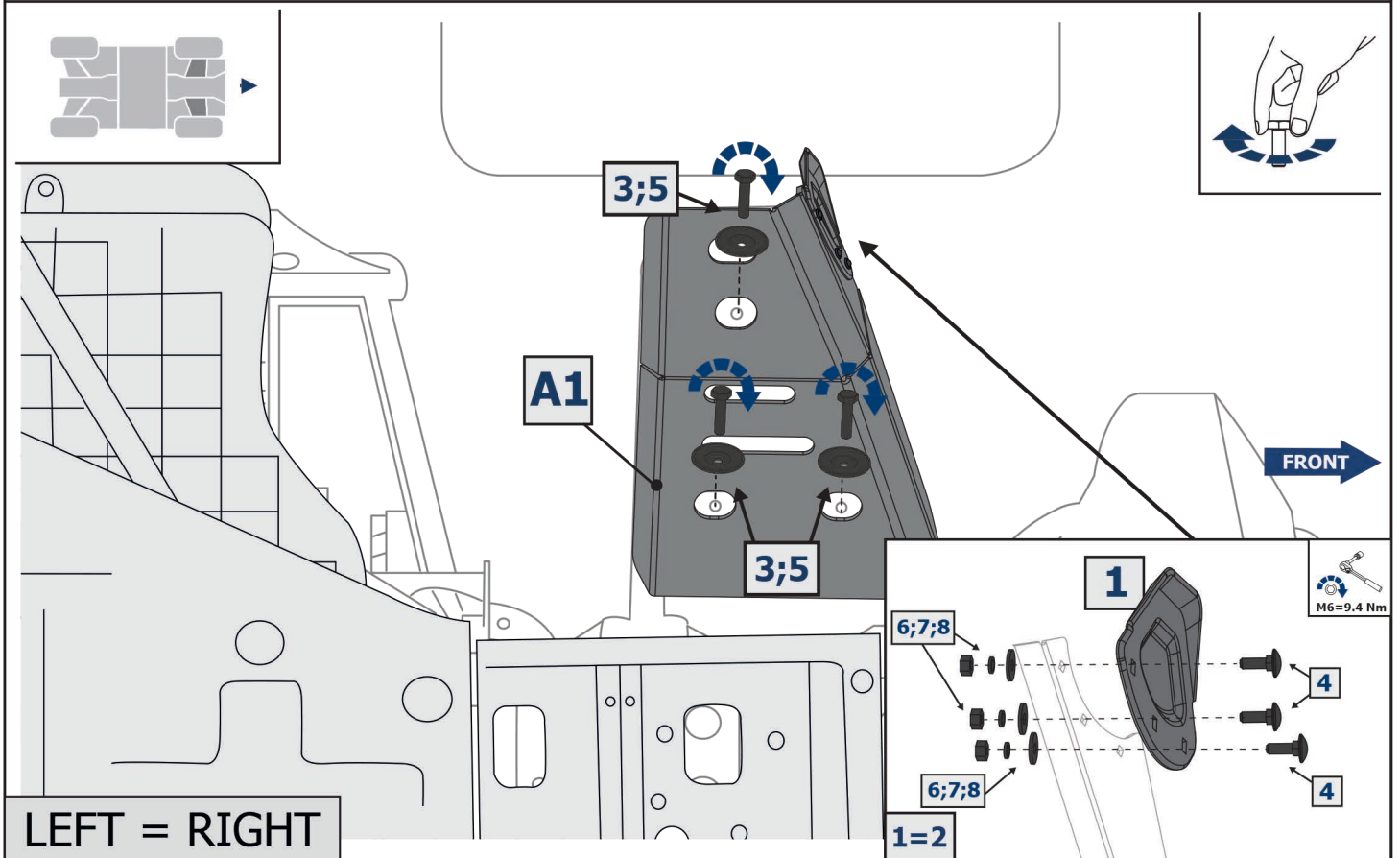
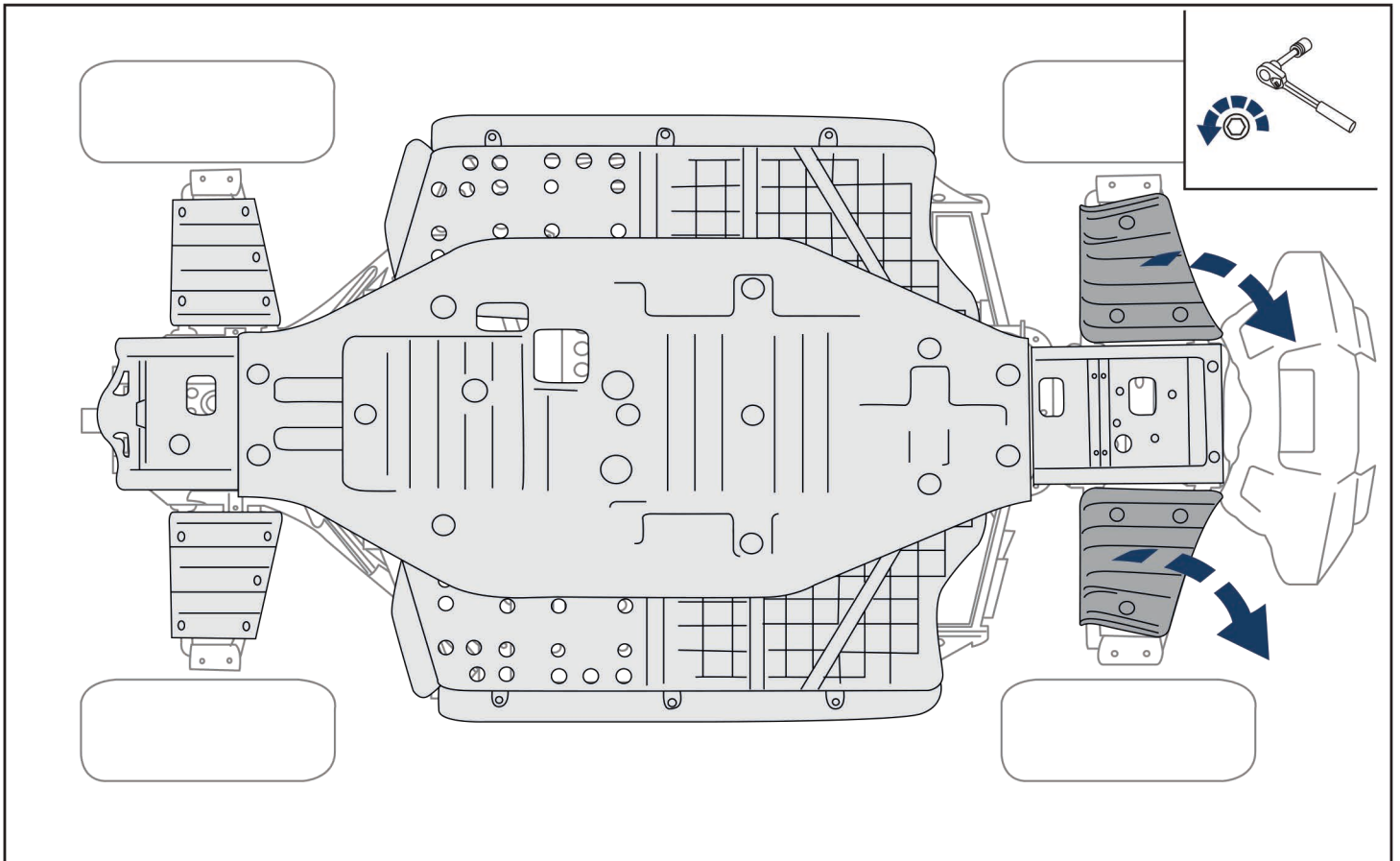



**M6=9.4 Nm**

