

EN

SKID PLATE INSTALLATION MANUAL

DE

MONTAGEANLEITUNG FÜR UNTERBODEN SCHUTZ SYSTEM



For: CF Moto Z8 (2013-)

2444.8141.1



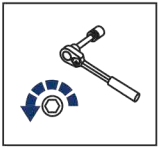

EN Regular fasteners
DE Originale montageile

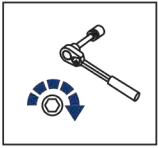

EN Regular fasteners
DE Originale montageile

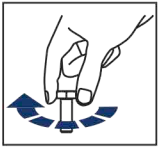

EN Screw a several turns
DE Für wenigen Umdrehungen befestigen

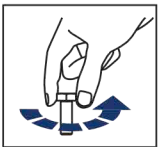

EN Loosen bolts
DE Bolzen lockern

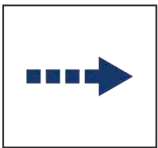

EN Movement Arrow
DE Bewegungsrichtung

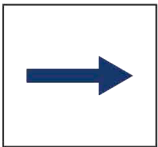







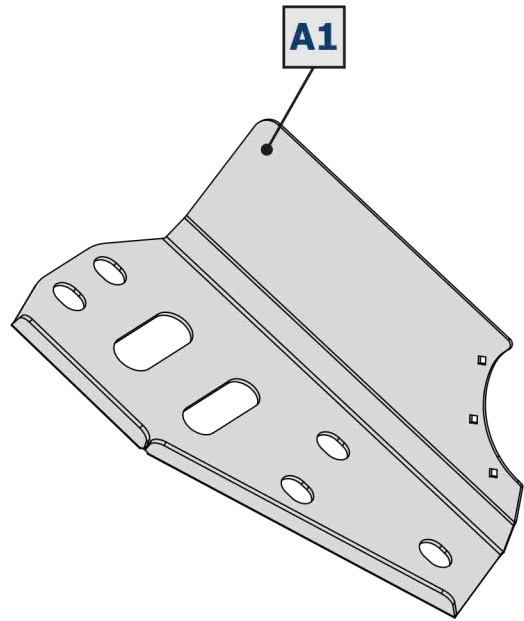
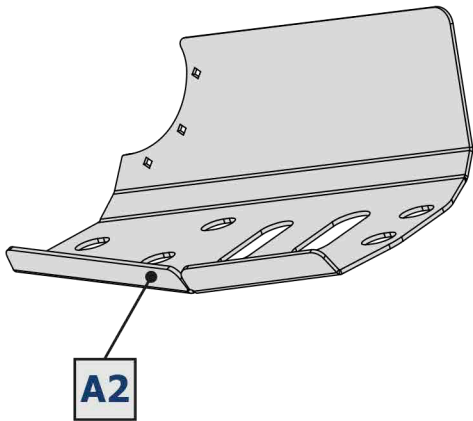
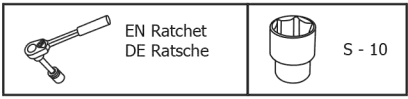

EN Location/Position Arrow
DE Anordnung/Positionsrichtung

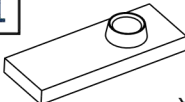

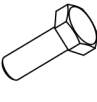
EN Screw Arrow
DE Drehungsrichtung



B1  x1	B2  x1	1  x4	2  Ø6 x10	3  M6x16 x6	4  M6x20 x10
5  Ø6 x6	6  Ø6 x6	7  M6 x4			

PRE-INSTALLATION: LAY OUT COMPONENTS AND COMPARE TO LIST AND IMAGES. IMAGES MAY NOT PORTRAY THE FULL DETAIL OR EXACT SHAPE OF THE PARTS; HOWEVER, THEY REPRESENT PARTS THAT HAVE SAME OR SIMILAR FUNCTION.

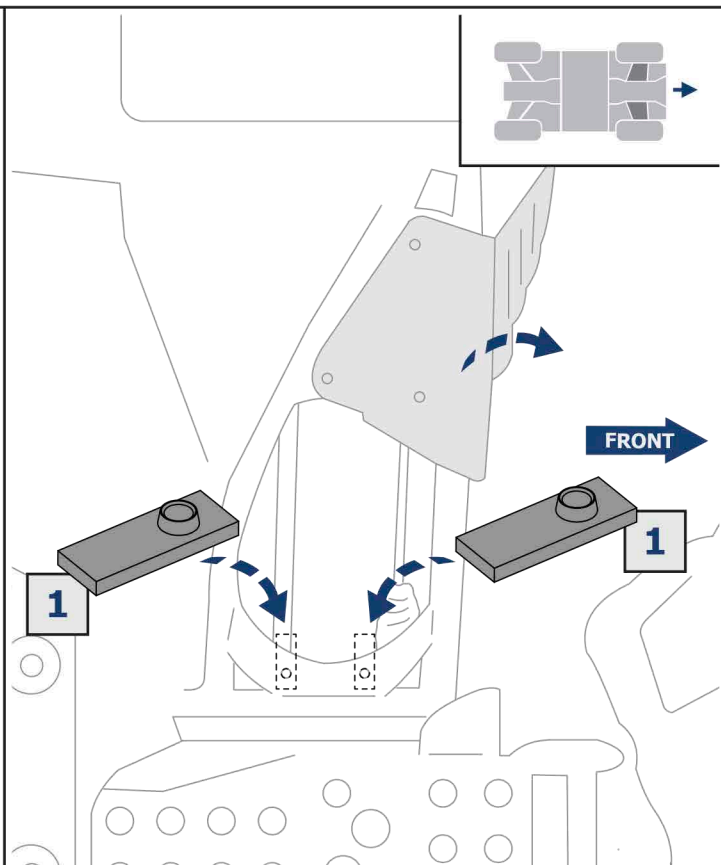
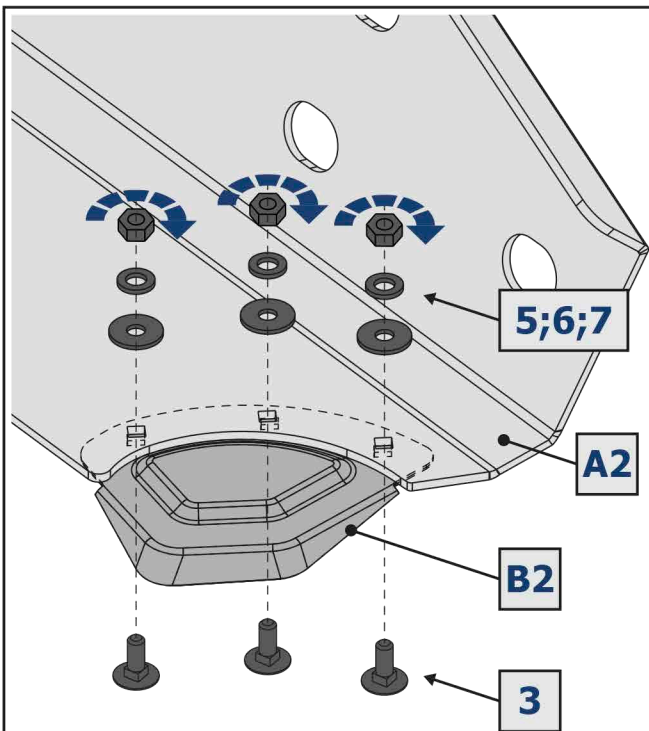

LEFT = RIGHT A1 = A2

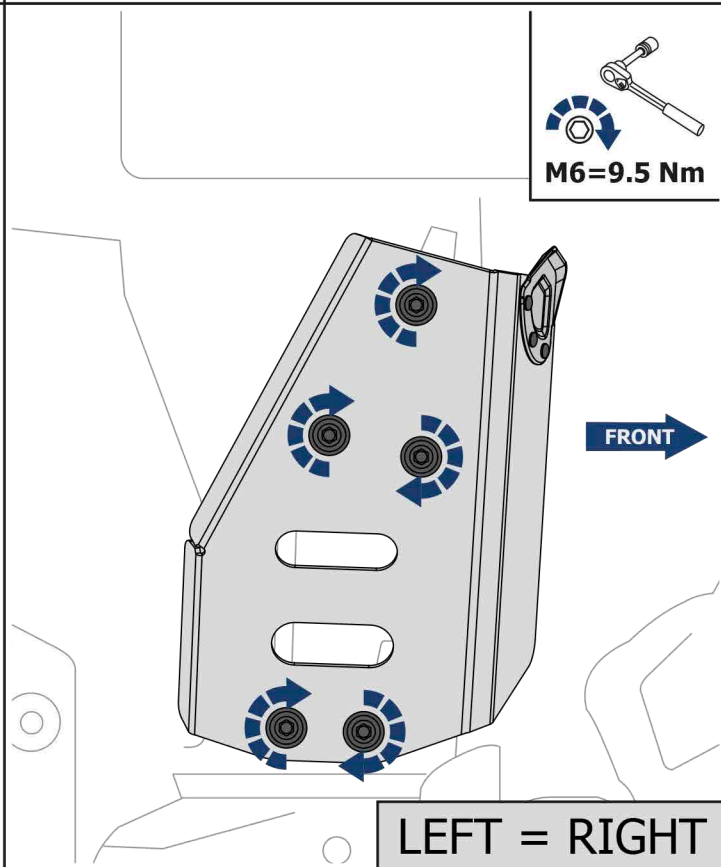
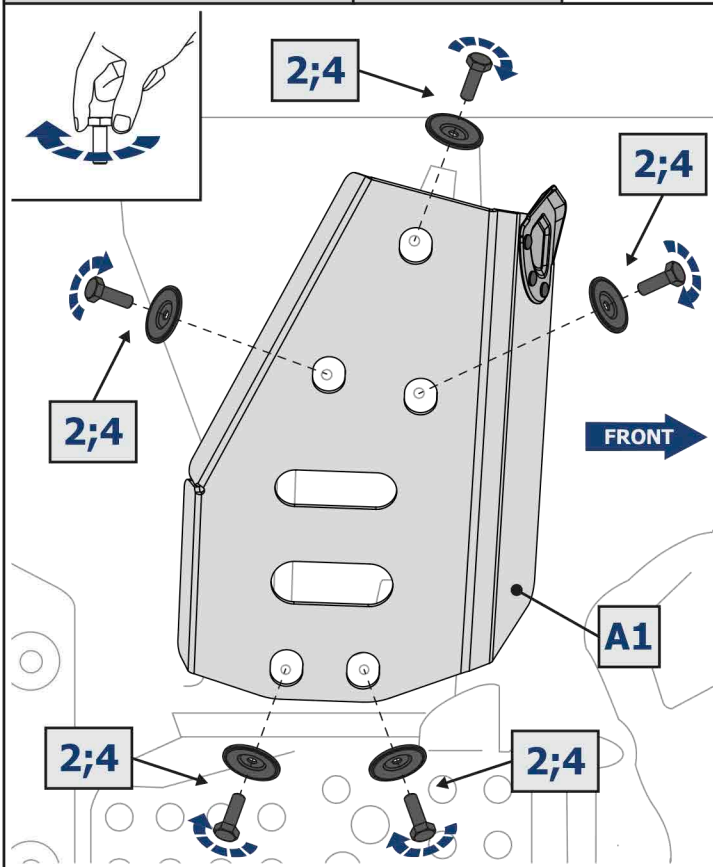

LEFT = RIGHT

TIP: PERIODICALLY CHECK ALL HARDWARE AND RE-TIGHTEN IF NEEDED.