

EN SKID PLATE INSTALLATION MANUAL

DE MONTAGEEINLEITUNG FÜR UNTERBODENSCHUTZSYSTEM



For: CFMoto Cforce 600/625 Touring (2020-)

2444.8129.1



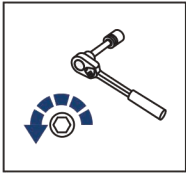

EN Regular fasteners
DE Schraube herausdrehen

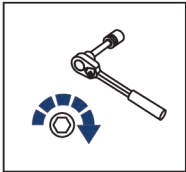

EN Regular fasteners
DE Schraube eindrehen und festziehen

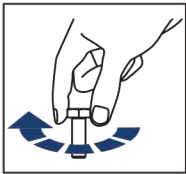

EN Screw a several turns
DE Schraube wenige Umdrehungen eindrehen

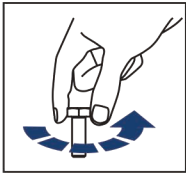

EN Loosen bolts
DE Schraube wenige Umdrehungen lösen

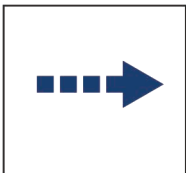



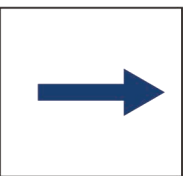

EN Movement Arrow
DE Bewegungsrichtung









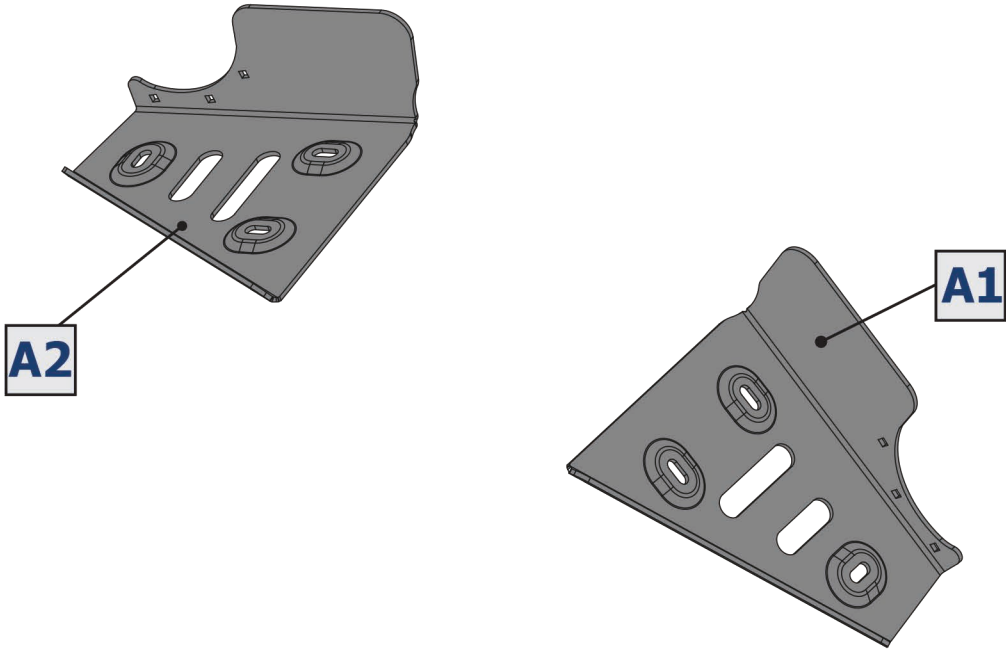

EN Location/Position Arrow
DE Blickrichtung / Postionsrichtung

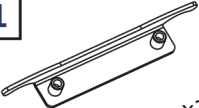

EN Screw Arrow
DE Drehrichtung

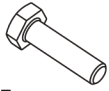
 EN Ratchet DE Ratsche	 S - 10; S - 13	 HEX S - 4;	 EN Office Knife DE Büromesser
--	---	---	---



1  x2	2  x2	3  x1	4  x1	5  M6x16 x6	6  M8x25 x6
7  M6 x6	8  Ø6 x6	9  Ø8 x6			

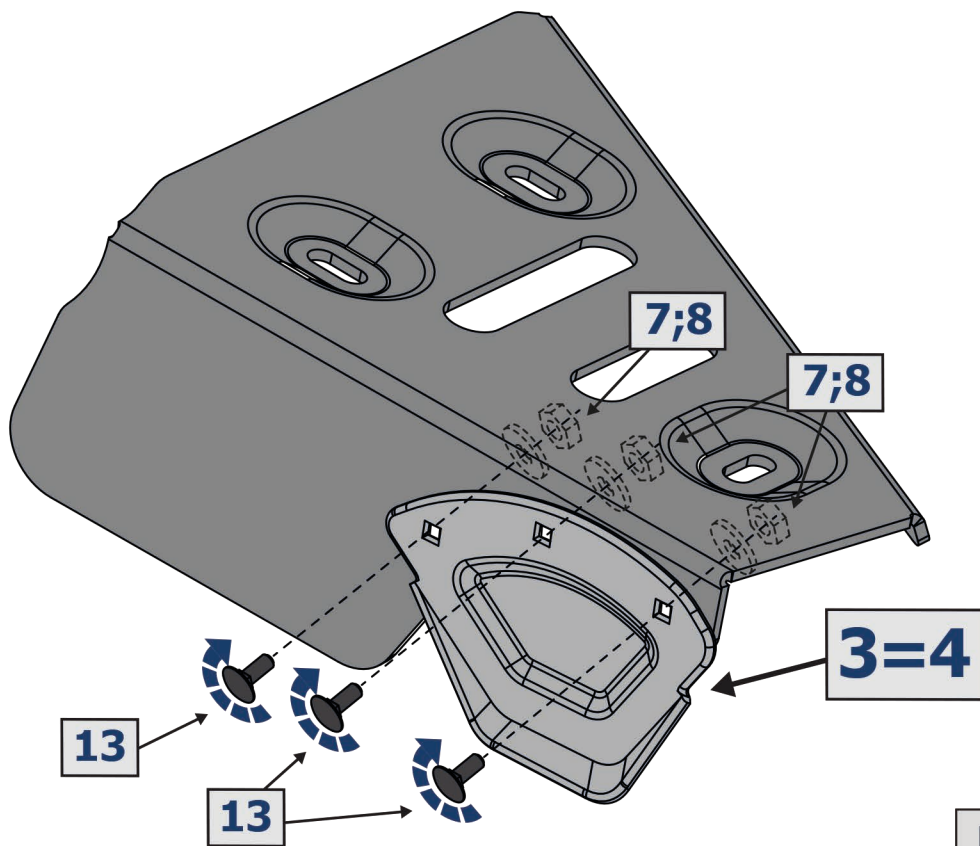

LEFT = RIGHT

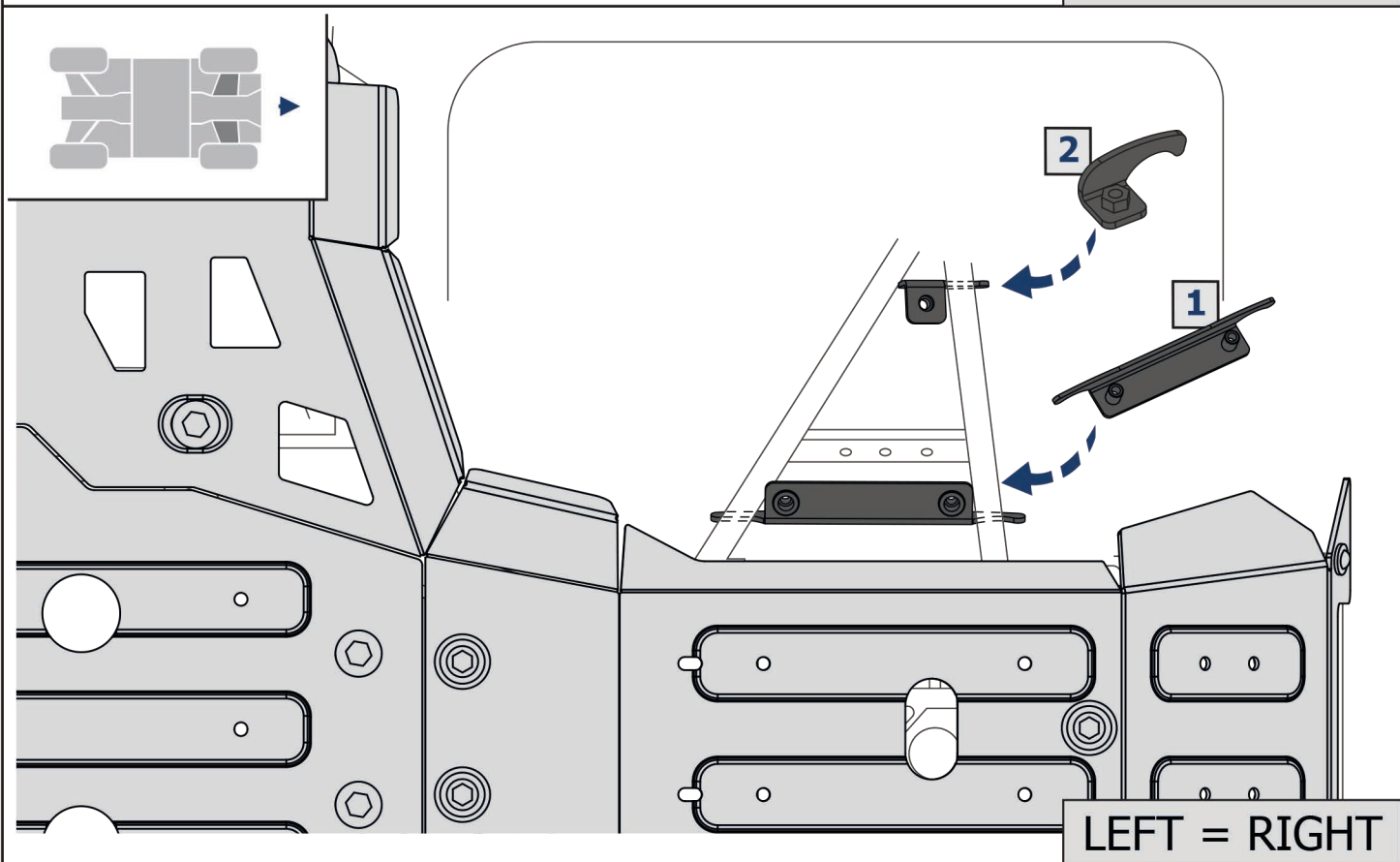

LEFT = RIGHT

