

EN BUMPER KIT INSTALLATION MANUAL

DE MONTAGEEINLEITUNG FÜR STOBFÄNGER-KIT



For: Kymco MXU 700 (2019-)

2444.7514.1



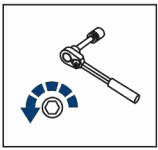

EN Regular fasteners
DE Originale montageile

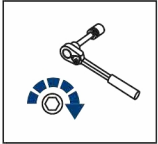

EN Regular fasteners
DE Originale montageile

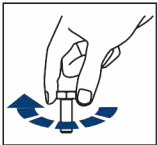

EN Screw a several turns
DE Für wenigen Umdrehungen befestigen



EN Loosen bolts
DE Bolzen lockern

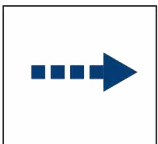

EN Movement Arrow
DE Bewegungsrichtung

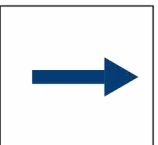



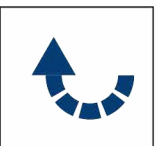

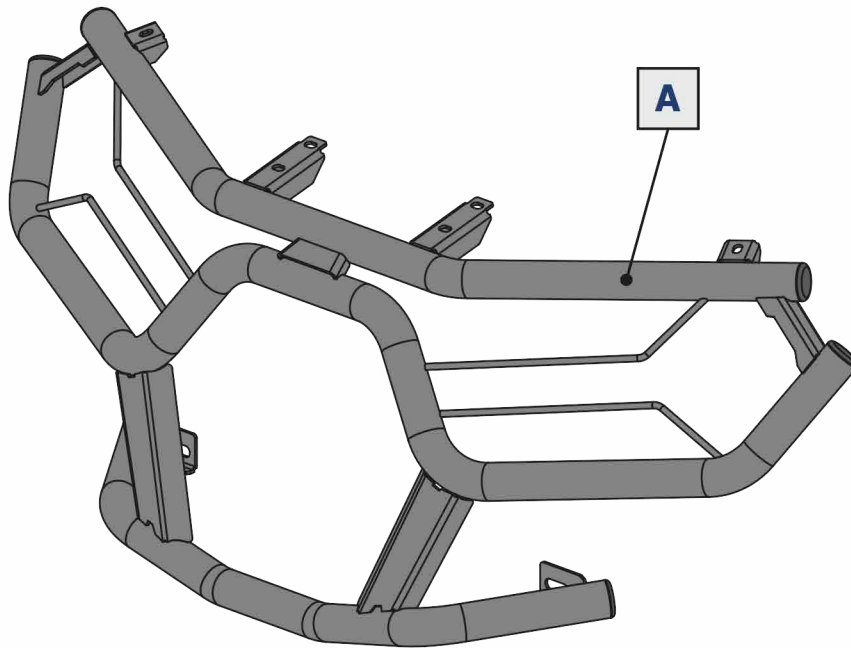

EN Location/Position Arrow
DE Amordnung/Positionsrichtung

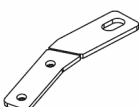
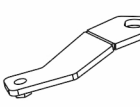
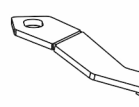
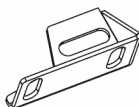
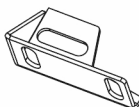

EN Screw Arrow
DE Drehungsrichtung



1  x1	2  x1	3  x1	4  x1	5  x1	6  x1
7  M6x20 x6	8  M8x30 x10	9  $\varnothing 6$ x6	10  $\varnothing 8$ x14	11  x2	12  M8 x4

