

EN

SKID PLATE INSTALLATION MANUAL

DE

MONTAGEANLEITUNG FÜR UNTERBODENSCHUTZ SYSTEM



**For: Polaris Ranger SP570 (2022)**

2444.7497.1



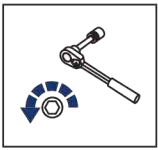

EN Regular fasteners  
DE Originale montageile

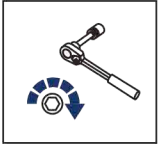

EN Regular fasteners  
DE Originale montageile

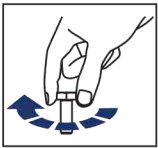

EN Screw a several turns  
DE Für wenigen Umdrehungen befestigen

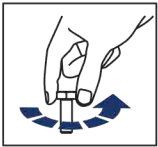

EN Loosen bolts  
DE Bolzen lockern

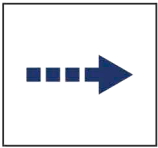

EN Movement Arrow  
DE Bewegungsrichtung

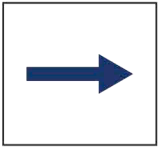



EN Location/Position Arrow  
DE Anordnung/Positionsrichtung

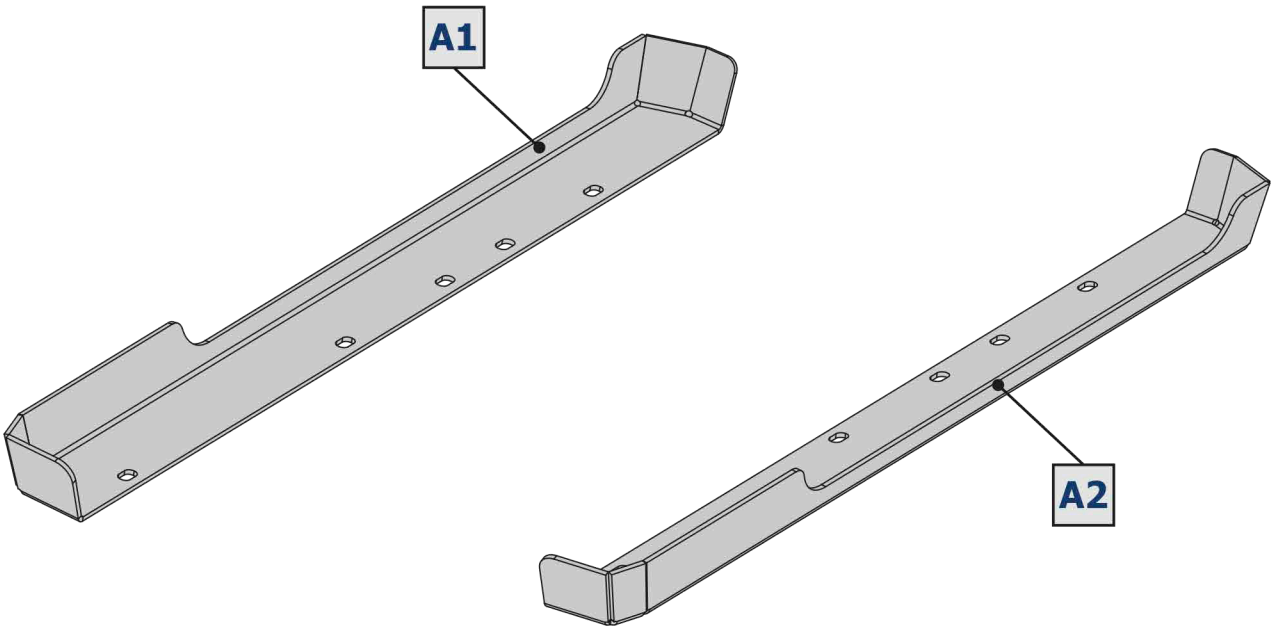

EN Screw Arrow  
DE Drehungsrichtung

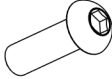

<b>1</b>		<b>2</b>	
M6x30	x6	ø6	x6

PRE-INSTALLATION: LAY OUT COMPONENTS AND COMPARE TO LIST AND IMAGES. IMAGES MAY NOT PORTRAY THE FULL DETAIL OR EXACT SHAPE OF THE PARTS; HOWEVER, THEY REPRESENT PARTS THAT HAVE SAME OR SIMILAR FUNCTION.

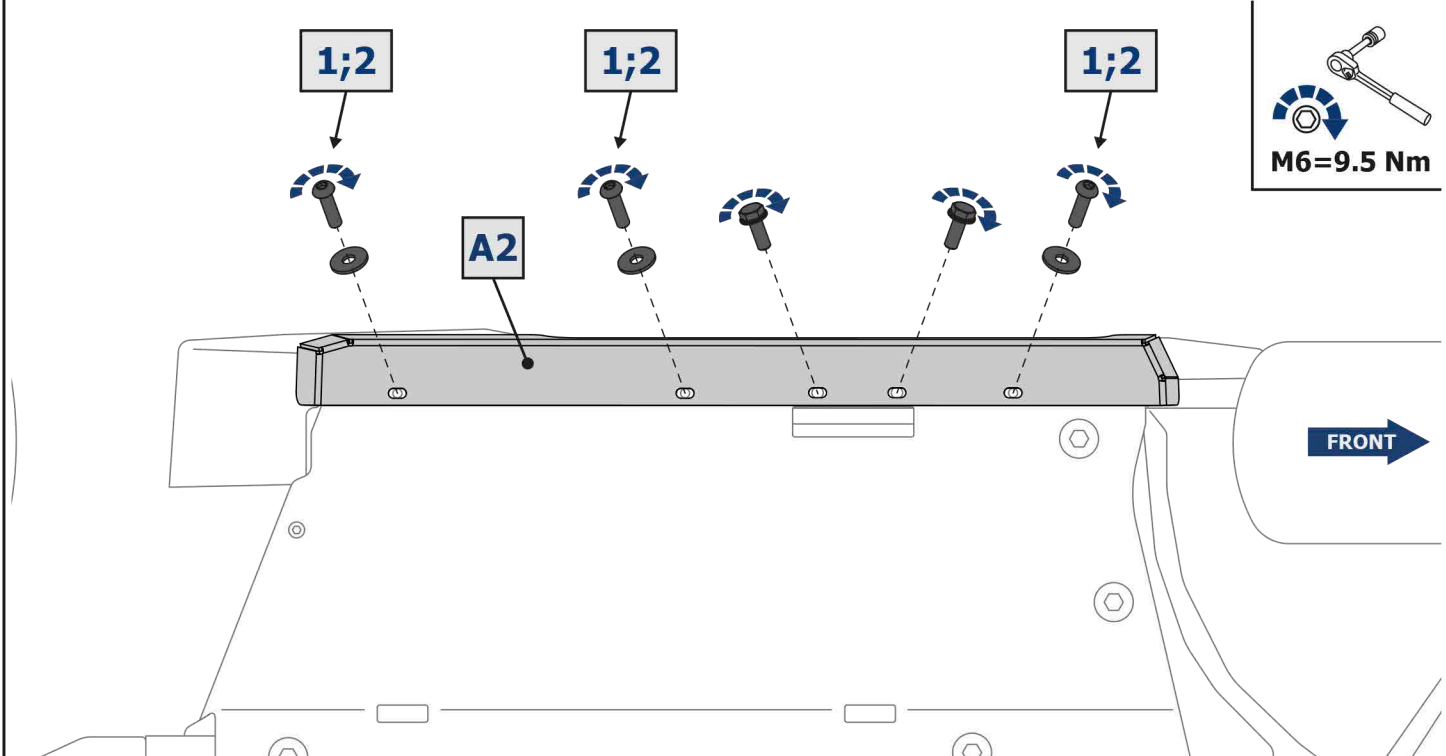
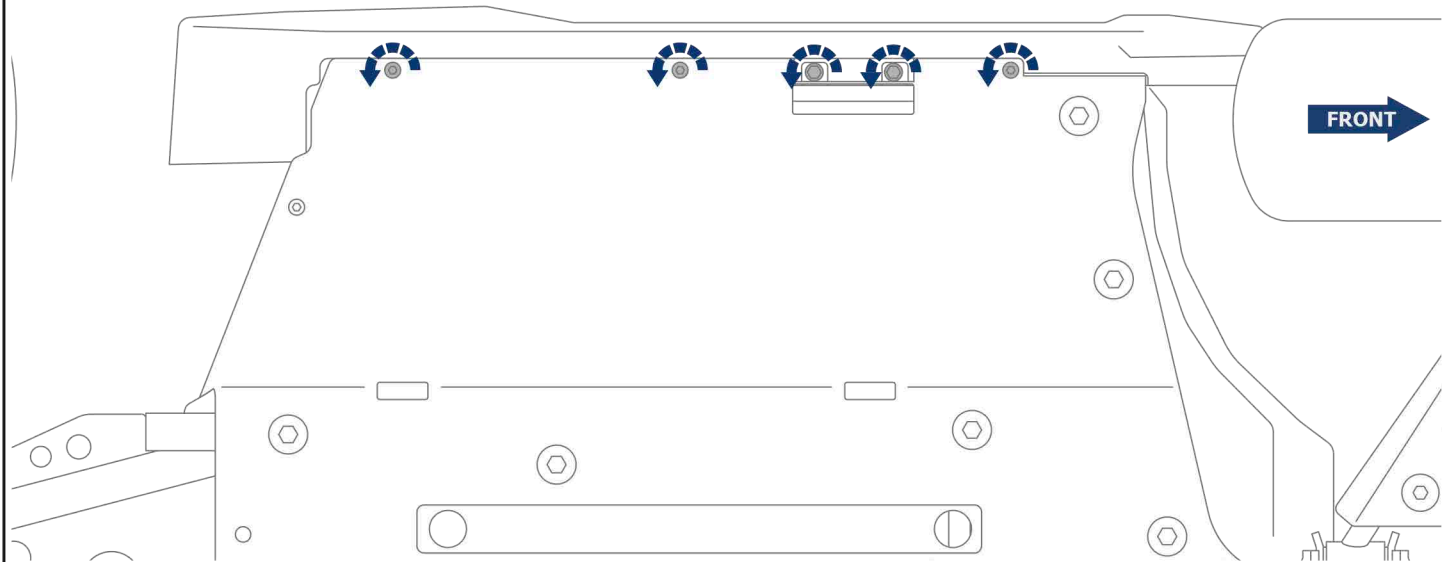
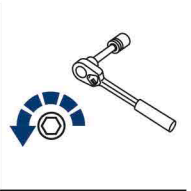

**LEFT = RIGHT**

**TIP: PERIODICALLY CHECK ALL HARDWARE AND RE-TIGHTEN IF NEEDED.**