

EN INSTALLATION MANUAL FRONT BUMPER

DE MONTAGEEINLEITUNG FÜR STOBFÄNGER-KIT

Fitting Video



For: POLARIS RANGER SP 570 (2022)

2444.7493.1



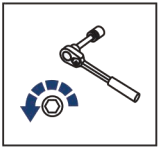

EN Regular fasteners
DE Originale montageile

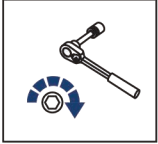

EN Regular fasteners
DE Originale montageile



EN Screw a several turns
DE Für wenigen Umdrehungen befestigen



EN Loosen bolts
DE Bolzen lockern

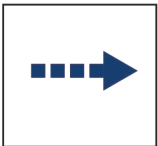

EN Movement Arrow
DE Bewegungsrichtung

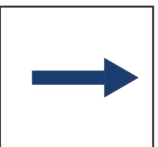



EN Location/Position Arrow
DE Anordnung/Positionsrichtung

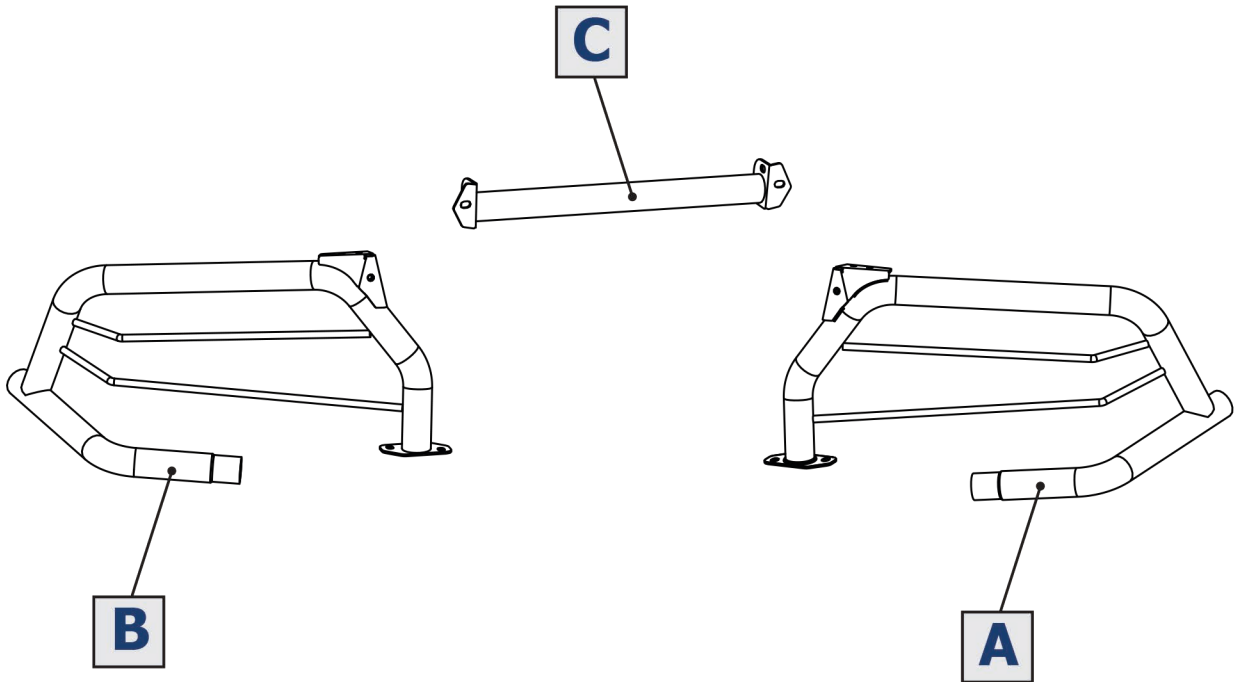
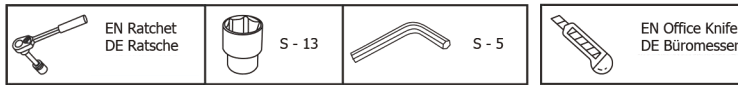

EN Screw Arrow
DE Drehungsrichtung



1		2		3				
M8x20	x8	Ø8	x12	M8	x4			

