

EN **SKID PLATE INSTALLATION MANUAL**

DE **MONTAGEEINLEITUNG FÜR UNTERBODENSCHUTZSYSTEM**



**For: Polaris RZR 1000 (2017- )**

2444.7490.1



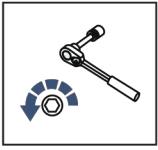

**EN Regular fasteners**  
**DE Normale Befestigung**

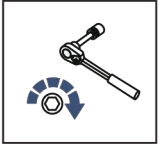

**EN Regular fasteners**  
**DE Normale Befestigung**

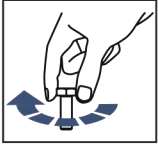

**EN Screw a several turns**  
**DE Mit wenigen Umdrehungen befestigen**

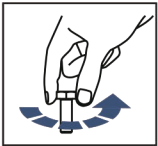

**EN Loosen bolts**  
**DE Bolzen lockern**

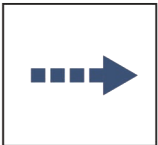



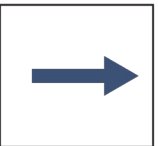

**EN Movement Arrow**  
**DE Bewegungsrichtung**



**EN Location / Position Arrow**  
**DE Anordnung / Positionsrichtung**



**EN Screw Arrow**  
**DE Drehrichtung**

 <p>EN Ratchet DE Ratsche</p>	 <p>S - 10; S - 13</p>	 <p>HEX S - 4; S - 5</p>	 <p>EN Office Knife DE Büromesser</p>
--	---	---	---

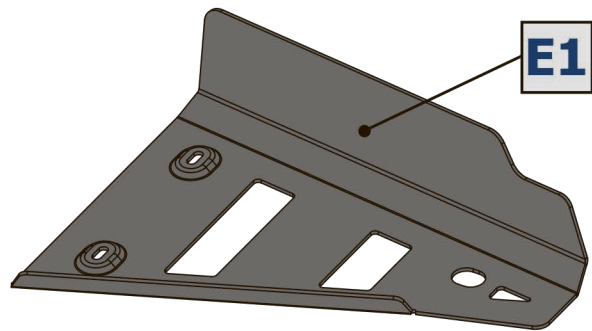
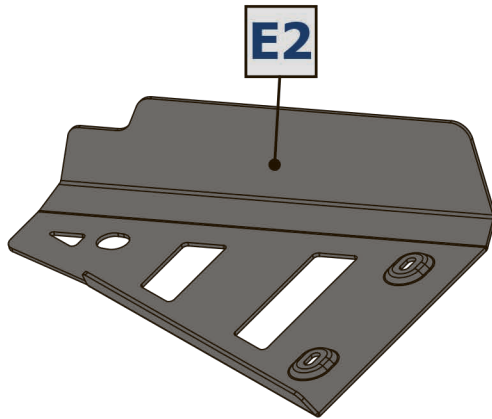

<p><b>1</b></p>  <p>x4</p>	<p><b>2</b></p>  <p>x2</p>	<p><b>3</b></p>  <p>x15</p>	<p><b>4</b></p>  <p>x6</p>	<p><b>5</b></p>  <p>x8</p>	<p><b>6</b></p>  <p>x9</p>
	M8	M8x25	M8x35	Ø8	Ø8

