

EN SKID PLATE INSTALLATION MANUAL

DE MONTAGEEINLEITUNG FÜR UNTERBODENSCHUTZSYSTEM



For: POLARIS RANGER SP 570 (2022)

2444.7486.1



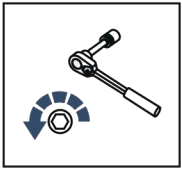

EN Regular fasteners
DE Originale montageteile

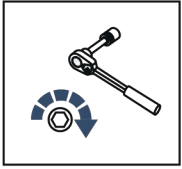

EN Regular fasteners
DE Originale montageteile

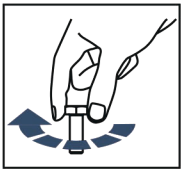

EN Screw a several turns
DE Für wenigen Umdrehungen befestigen

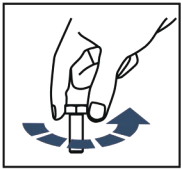

EN Loosen bolts
DE Bolzen lockern

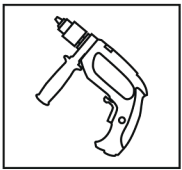

EN Drill
DE Bohrer

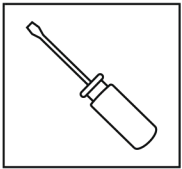

EN Screwdriver
DE Schraubenzieher

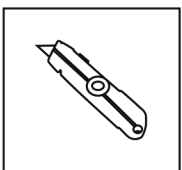

EN Office Knife
DE Büromesser

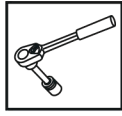

EN Ratchet
DE Ratsche

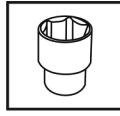

S - 10;
S - 13

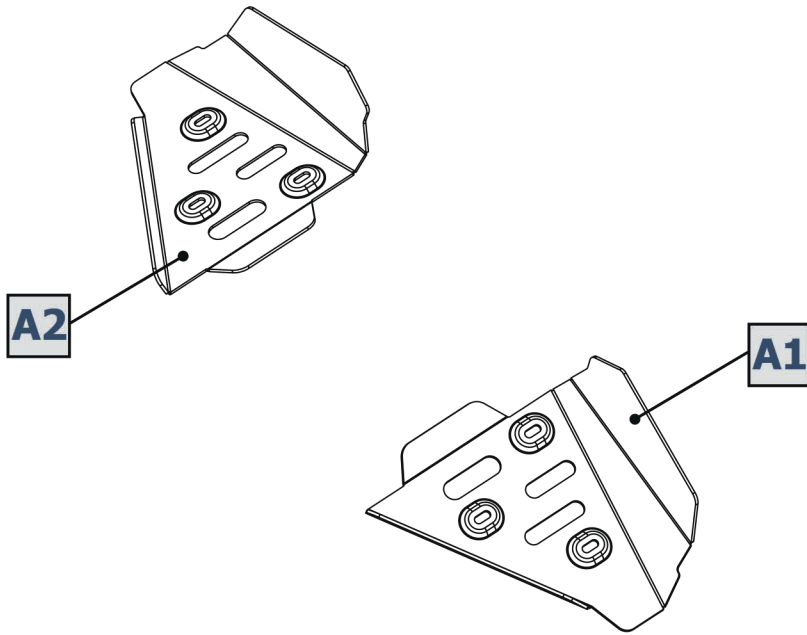

1

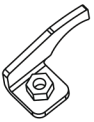

x6

2



M8x25

x6

3



Ø8

x6

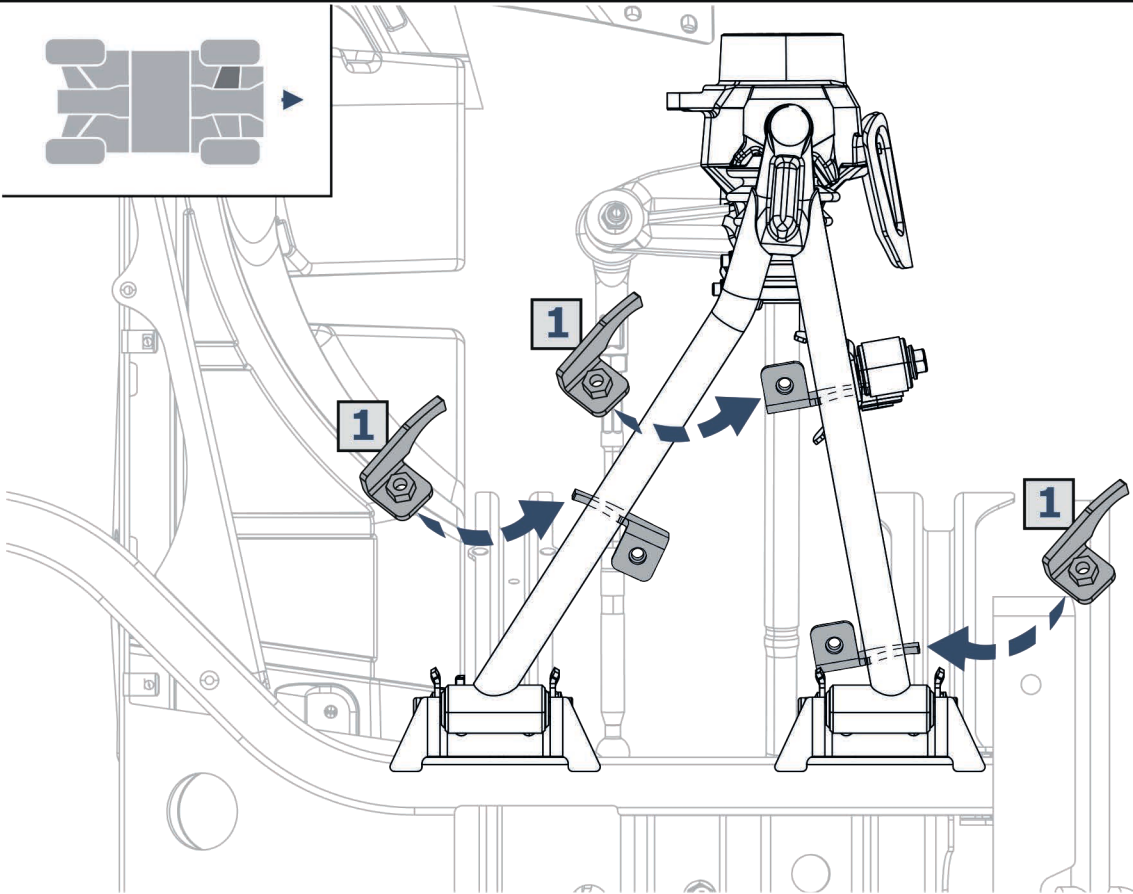
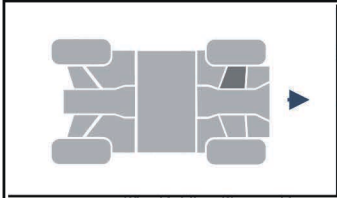
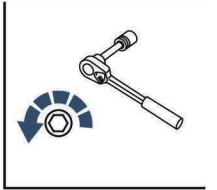
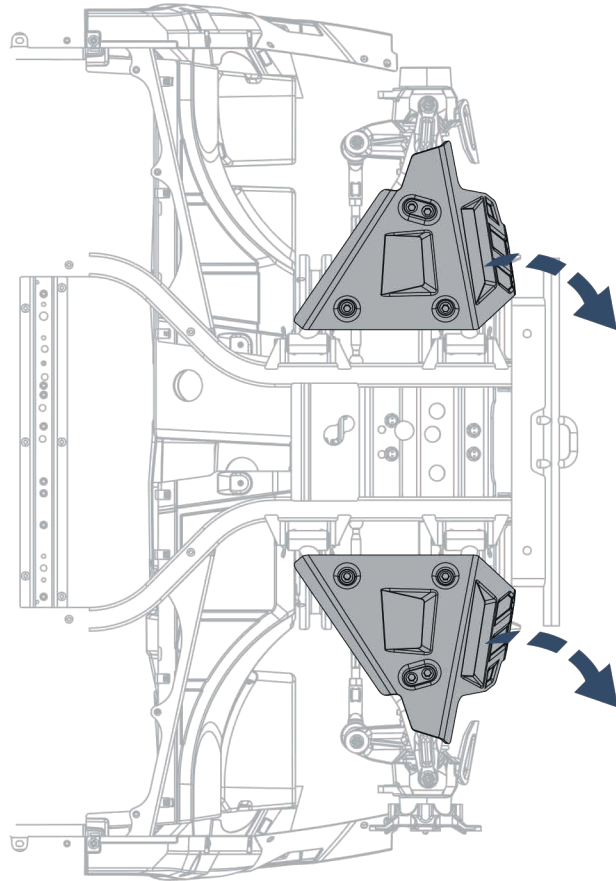
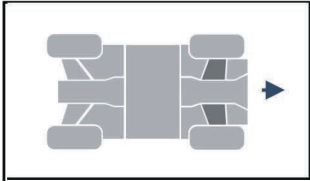

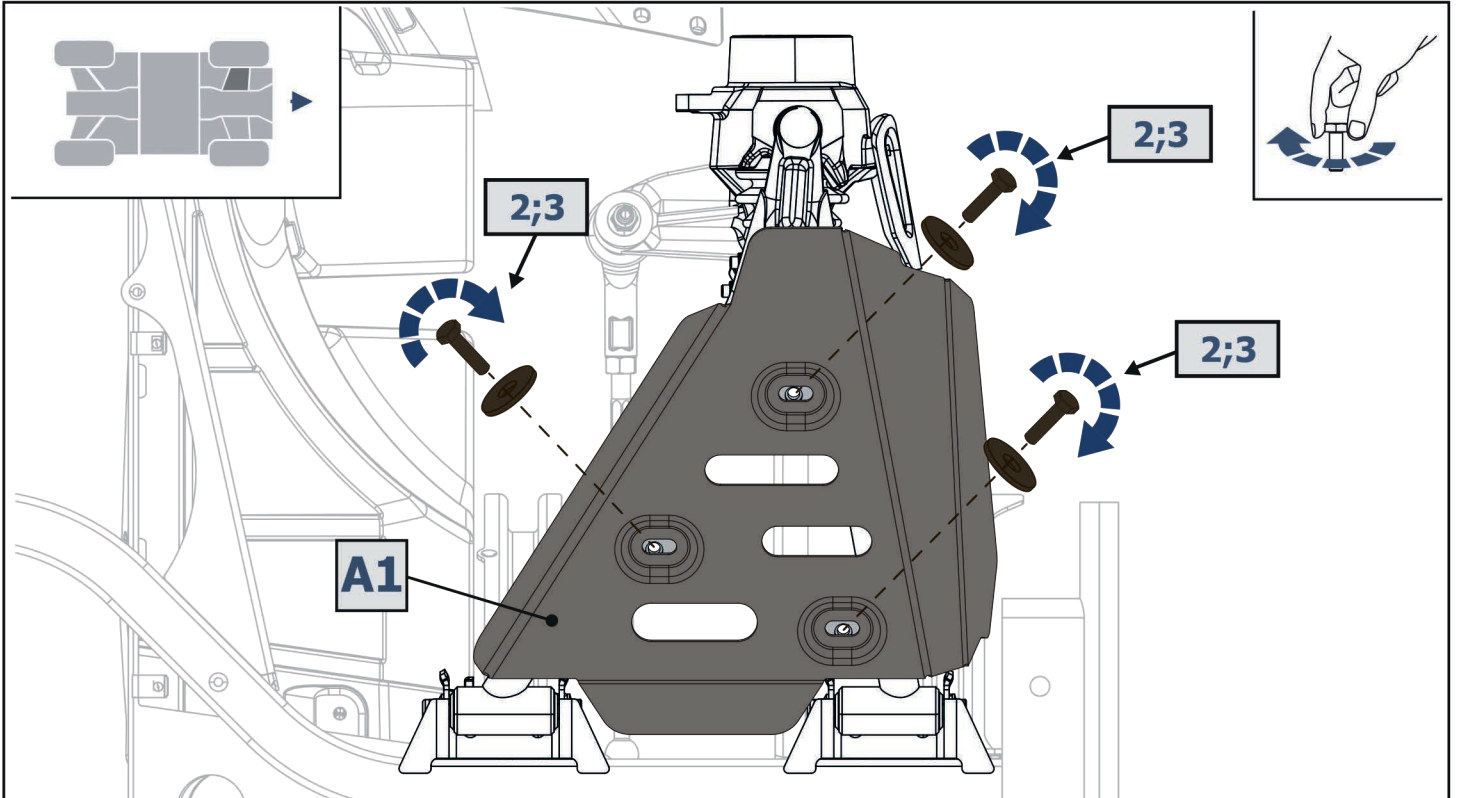

A1=A2

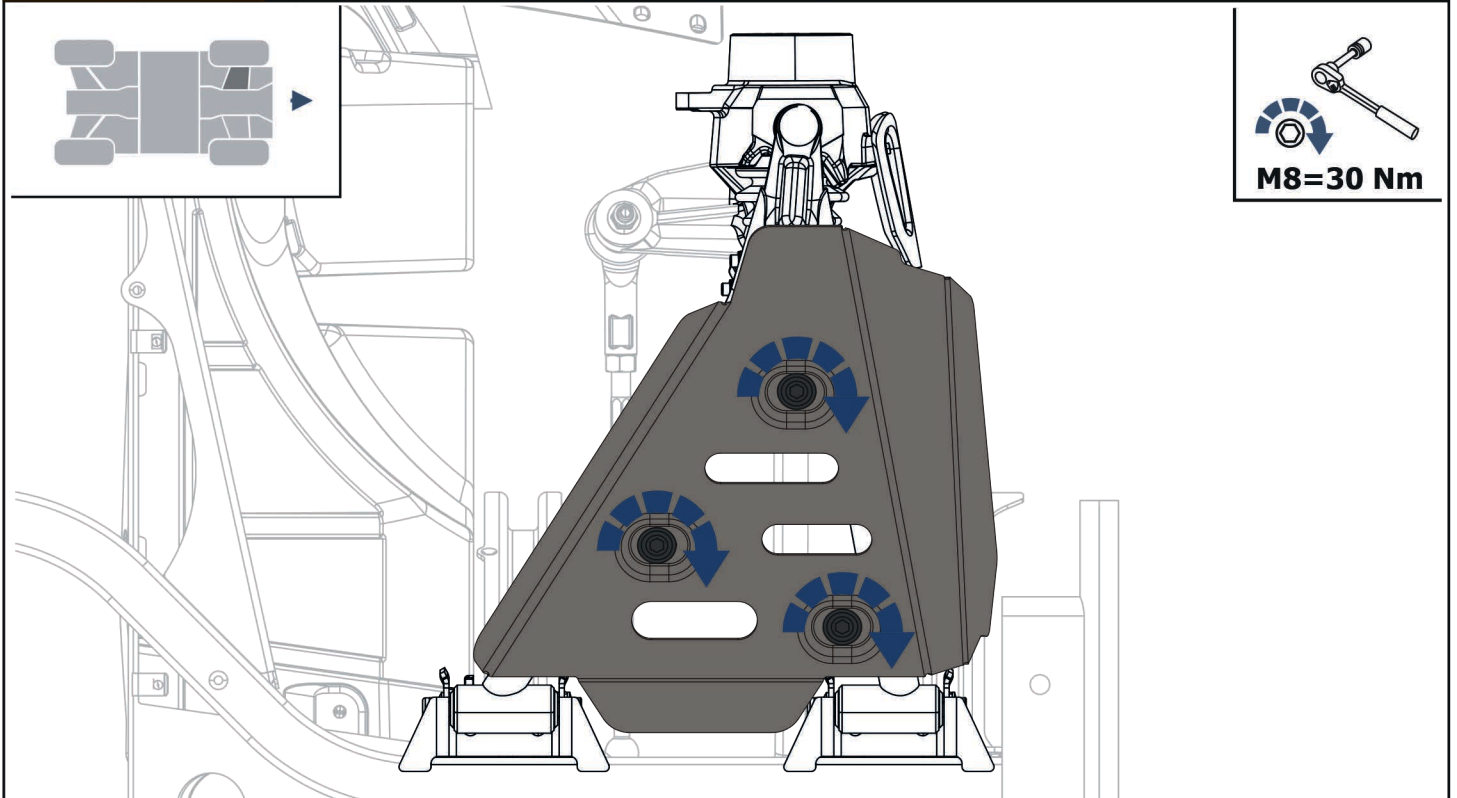

A1=A2