

EN **SKID PLATE INSTALLATION MANUAL**

DE **MONTAGEEINLEITUNG FÜR UNTERBODENSCHUTZSYSTEM**



For: Polaris Ranger XP 1000 Crew (2021-)

2444.7471.2



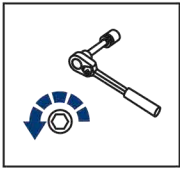

EN Regular fasteners
DE Originale montageteile

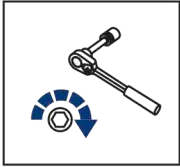

EN Regular fasteners
DE Originale montageteile

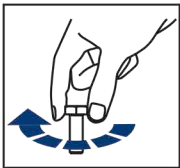

EN Screw a several turns
DE Für wenigen Umdrehungen befestigen

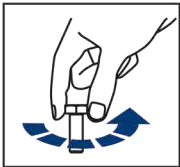

EN Loosen bolts
DE Bolzen lockern

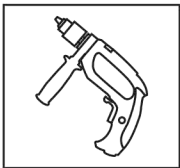

EN Drill
DE Bohrer

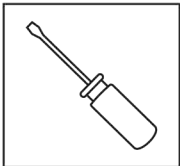

EN Screwdriver
DE Schraubenzieher

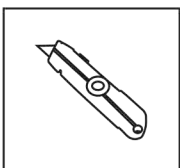

EN Office Knife
DE Büromesser

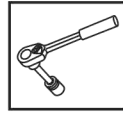

EN Ratchet
DE Ratsche

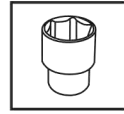

S - 10;
S - 13

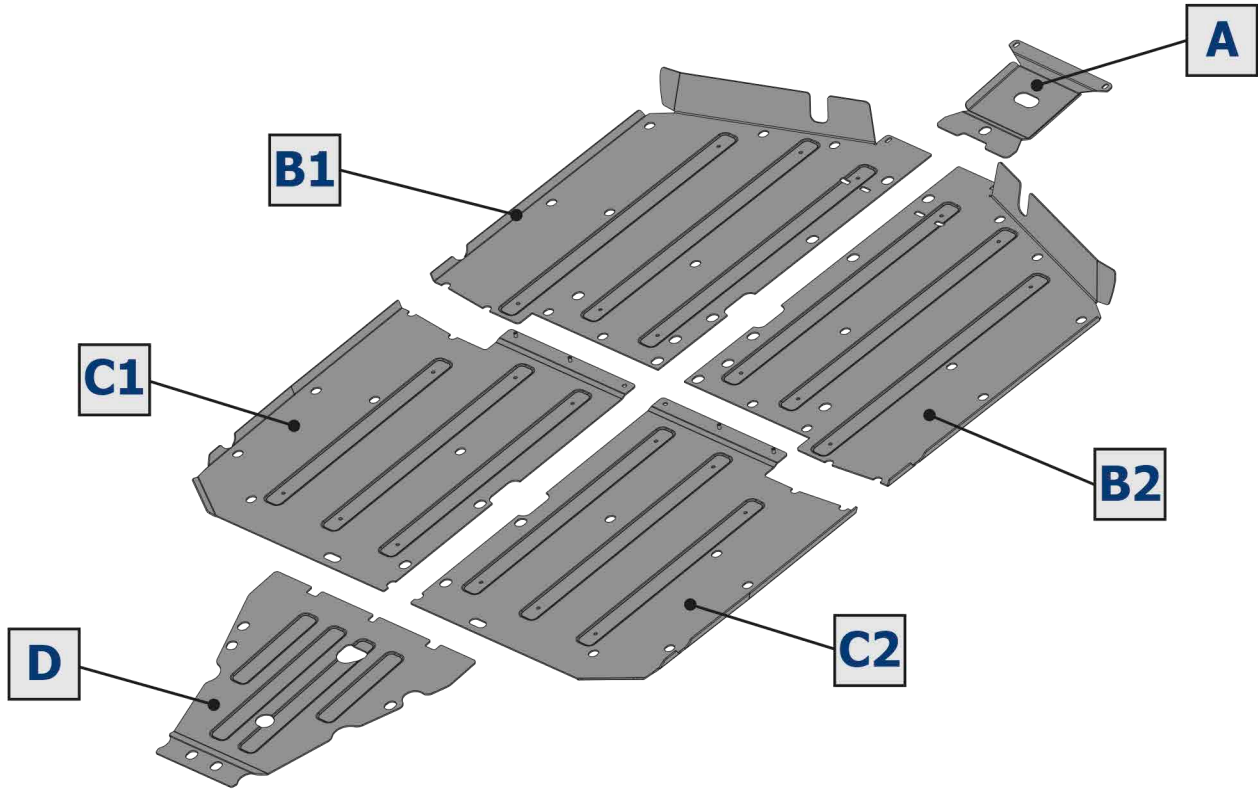

1 x2	2 x2	3 x4	4 x4	5 x5	6 Ø8 x21
7 M6x25 x33	8 M8x40 x4	9 M8x25 x7	10 M8x20 x12	11 Ø6 x33	12 Ø8 x4

