

EN SKID PLATE INSTALLATION MANUAL

DE MONTAGEEINLEITUNG FÜR UNTERBODENSCHUTZSYSTEM

RU ИНСТРУКЦИЯ ПО УСТАНОВКЕ КОМПЛЕКТА ЗАЩИТ



**For: Polaris Ranger 900/1000 (2018- )**

2444.7448.1

444.7448.1



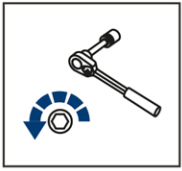

EN Regular fasteners  
DE Originale montageteile  
RU Штатный крепеж

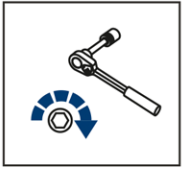

EN Regular fasteners  
DE Originale montageteile  
RU Штатный крепеж



EN Screw a several turns  
DE Für wenigen Umdrehungen befestigen  
RU Вкрутить на несколько оборотов



EN Loosen bolts  
DE Bolzen lockern  
RU Выкрутить на несколько оборотов

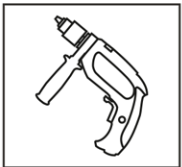

EN Drill  
DE Bohrer  
RU Дрель

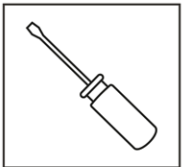

EN Screwdriver  
DE Schraubenzieher  
RU Отвертка

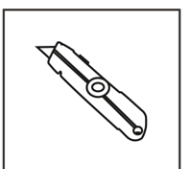

EN Office Knife  
DE Büromesser  
RU Канцелярский нож

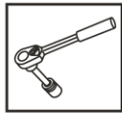

EN Ratchet  
DE Ratsche  
RU Трещётка

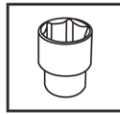



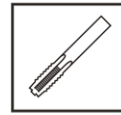



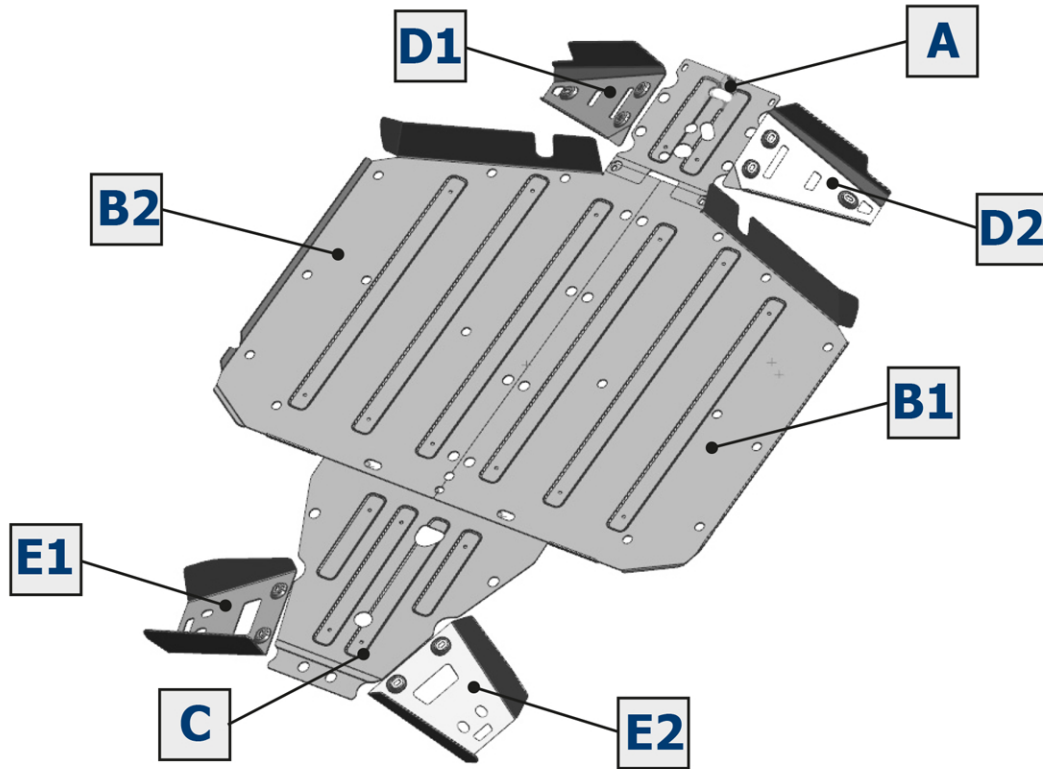

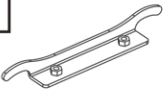
S - 10;  
S - 13



M6

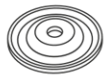
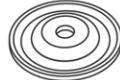

<b>1</b>		<b>2</b>		<b>3</b>		<b>4</b>		<b>5</b>		<b>6</b>	
	x2		x2		x2		x4		x2		M8x60/30 x10
<b>7</b>		<b>8</b>		<b>9</b>		<b>10</b>		<b>11</b>			
	M6x25 x22		M8x25 x32		Ø8 x10		Ø6 x22		Ø8 x22		

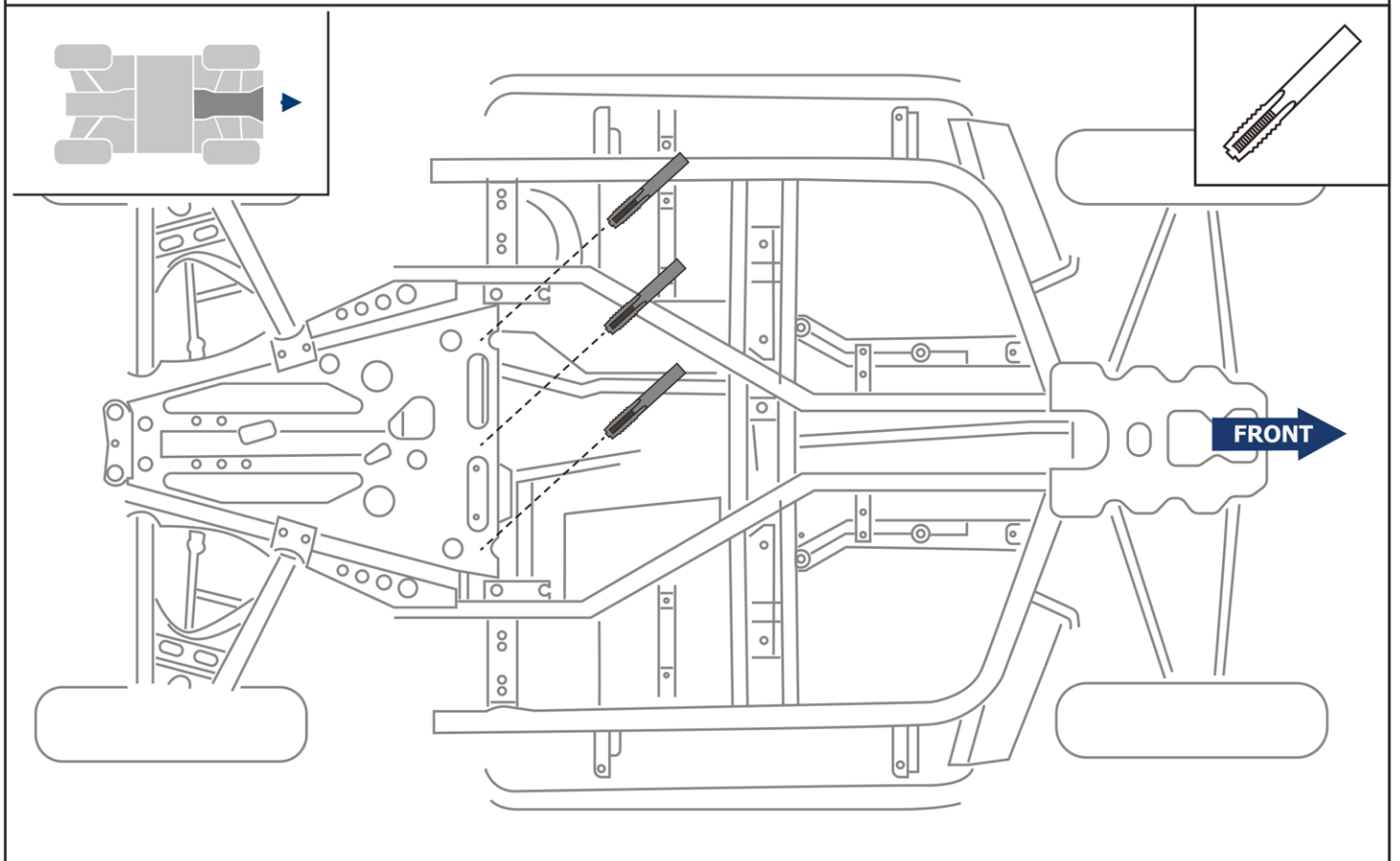
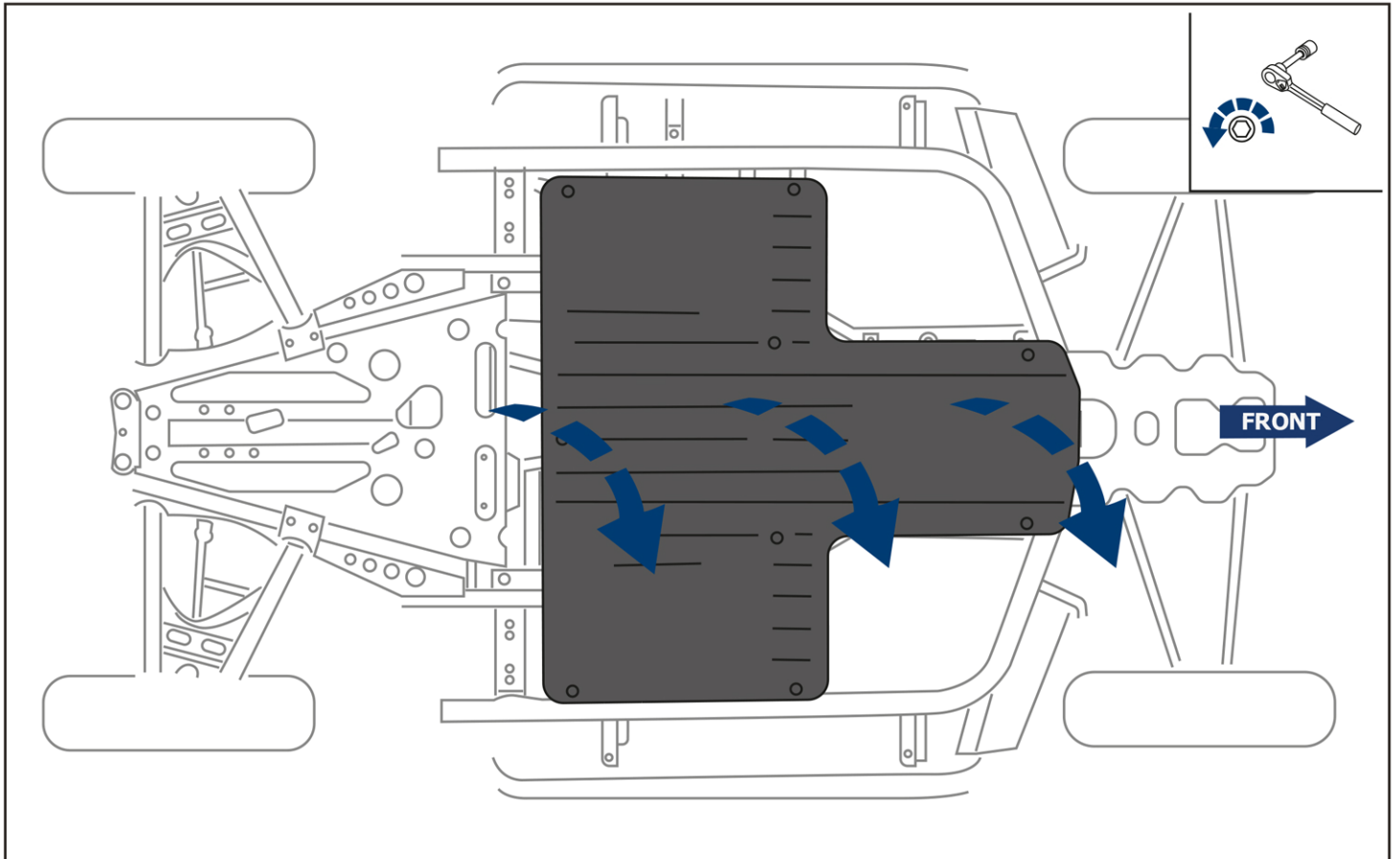

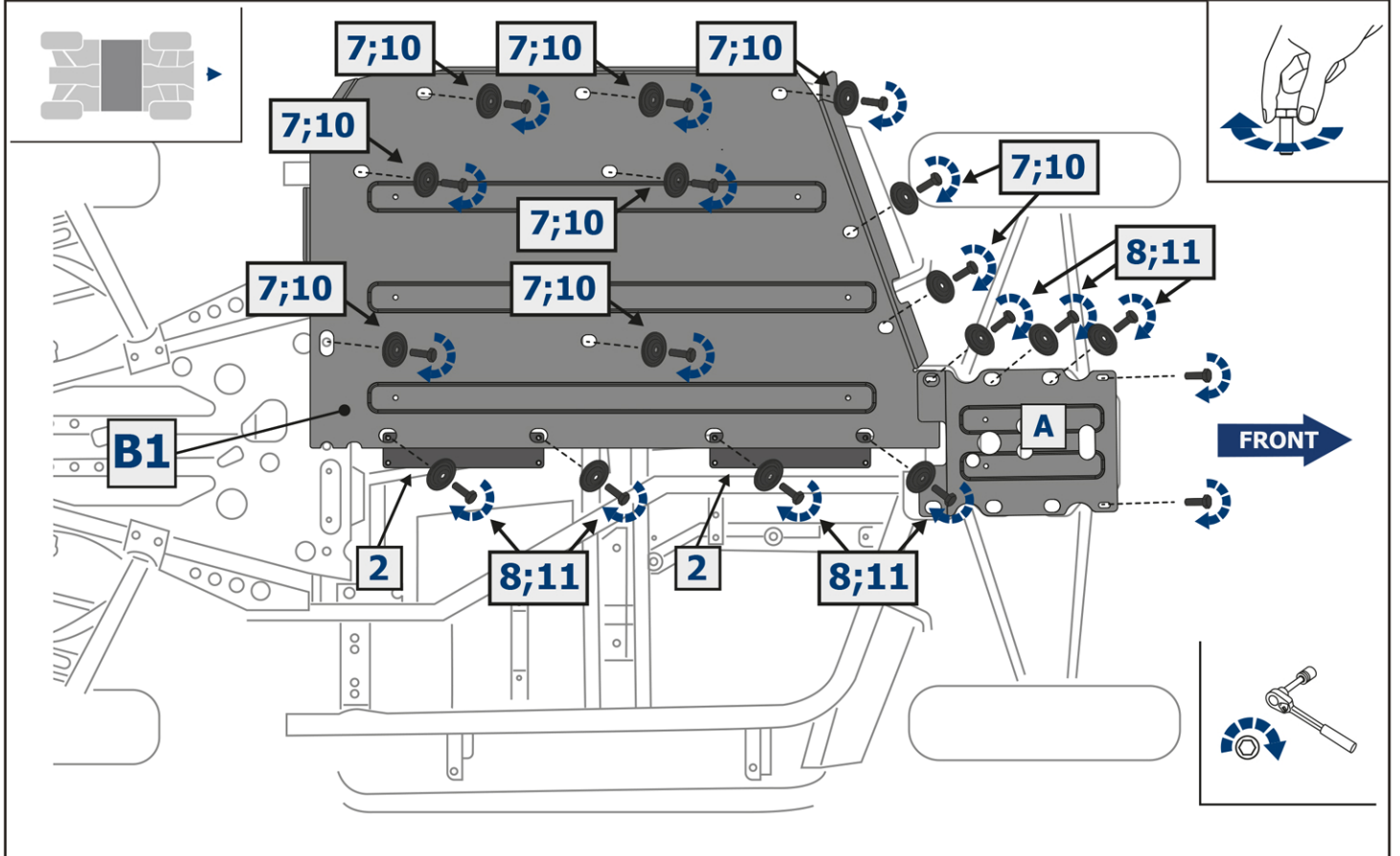
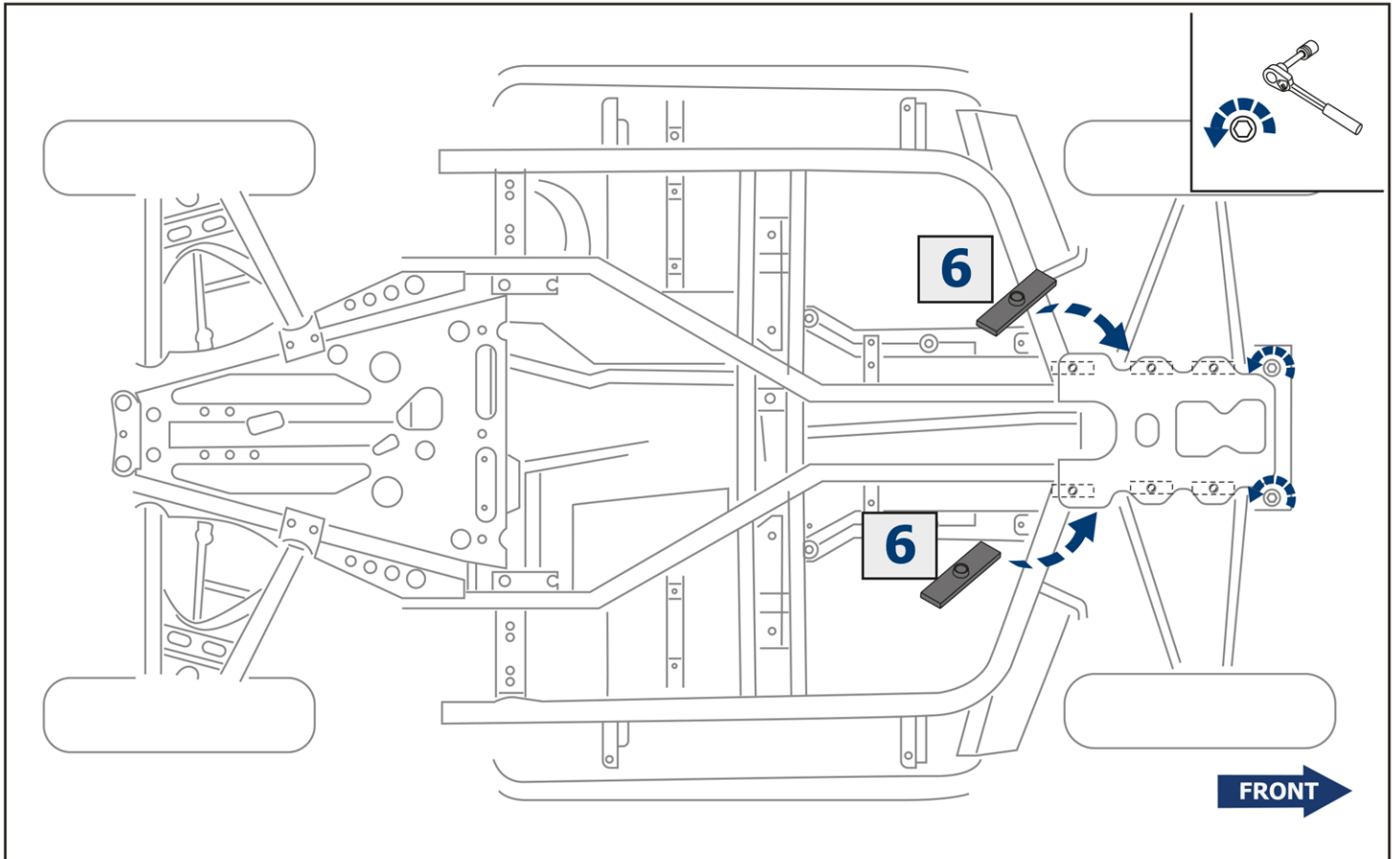

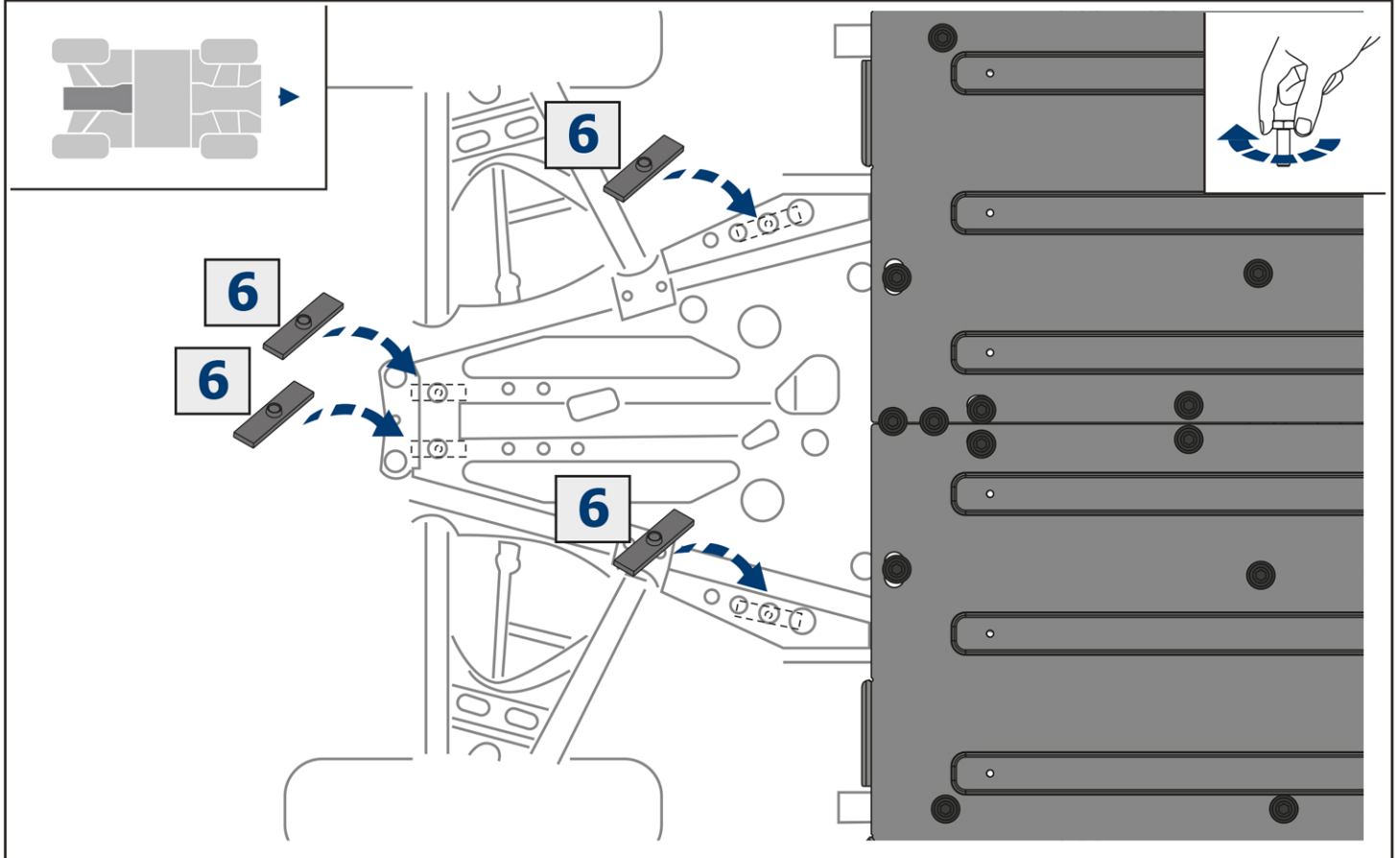
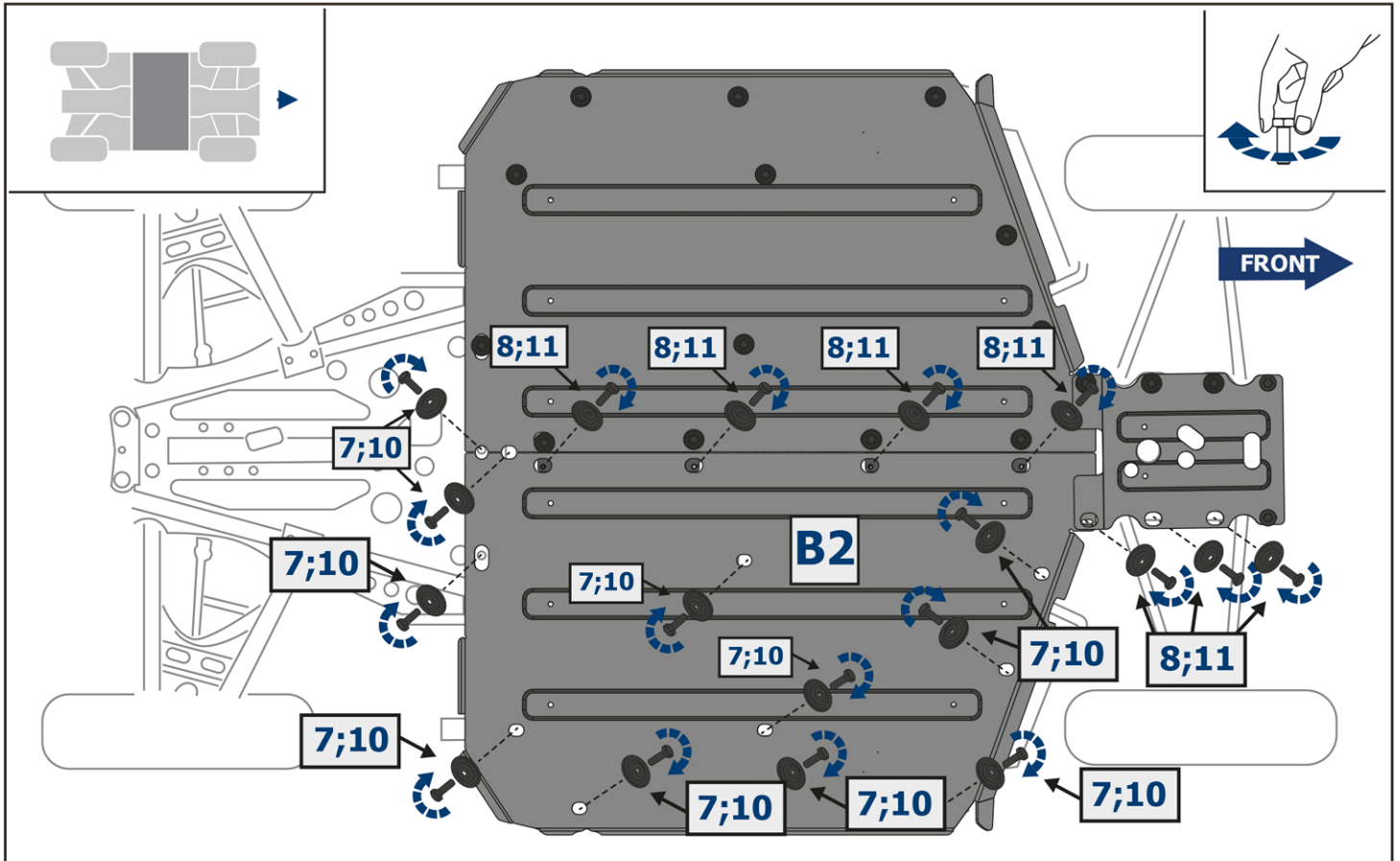

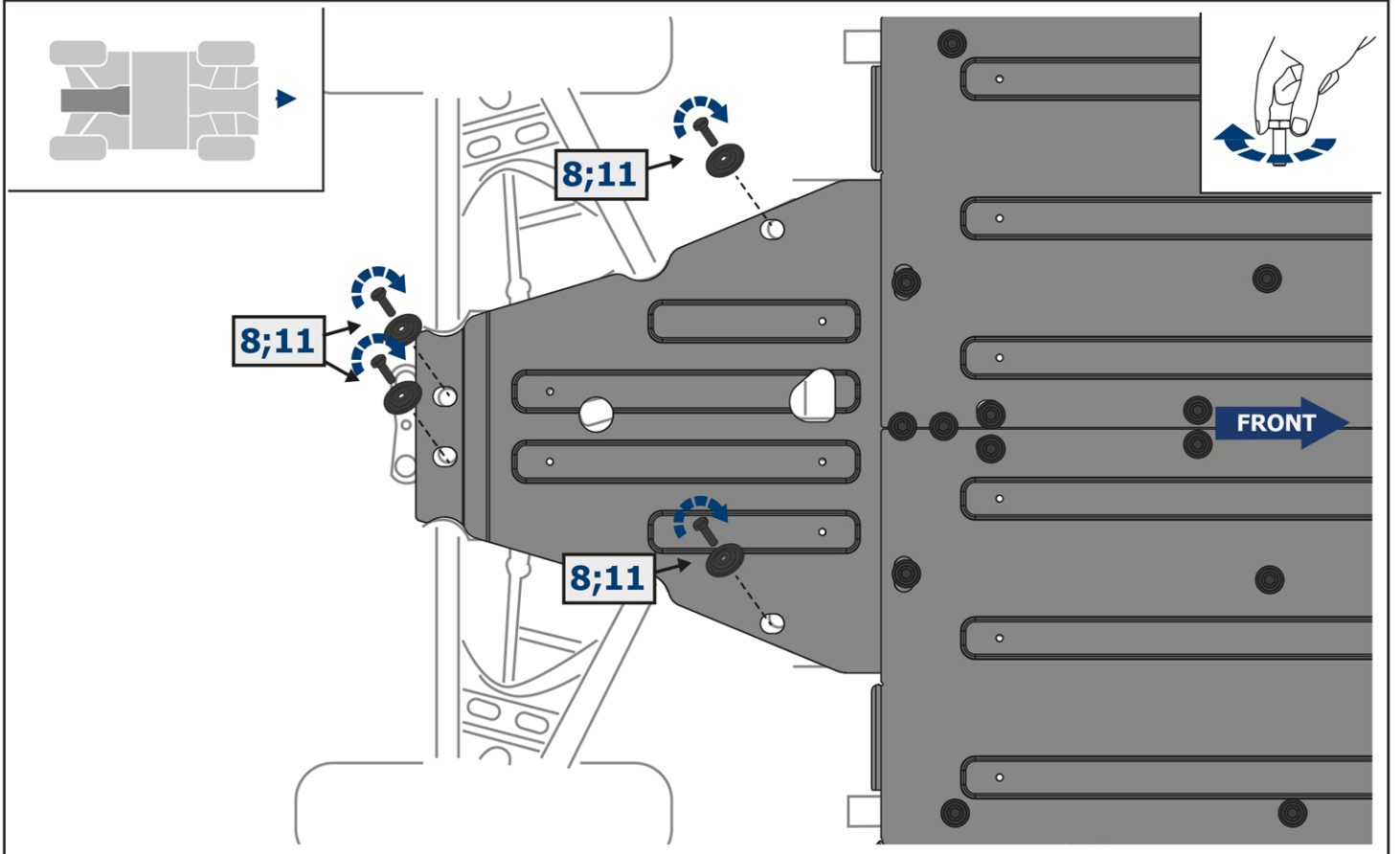
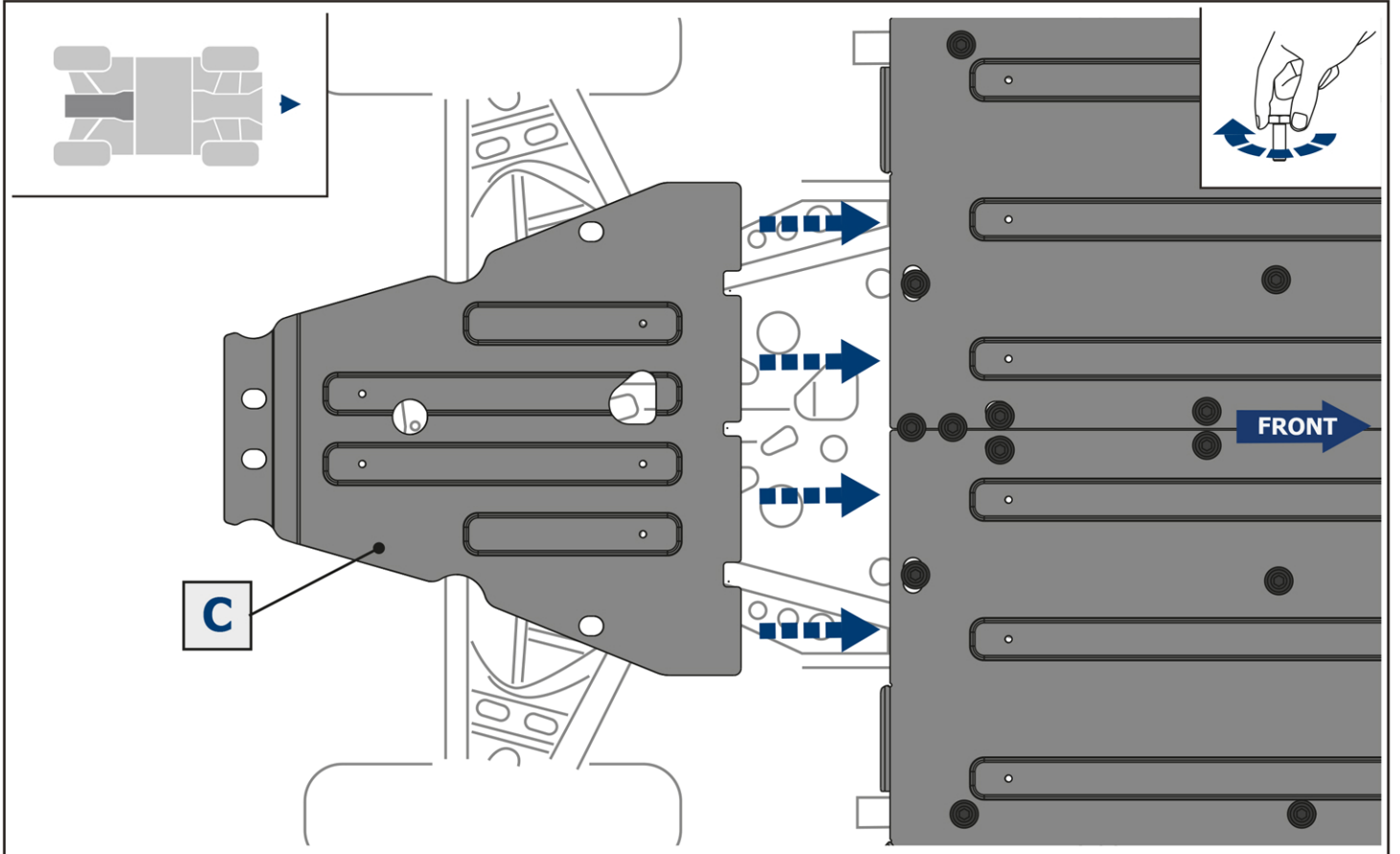

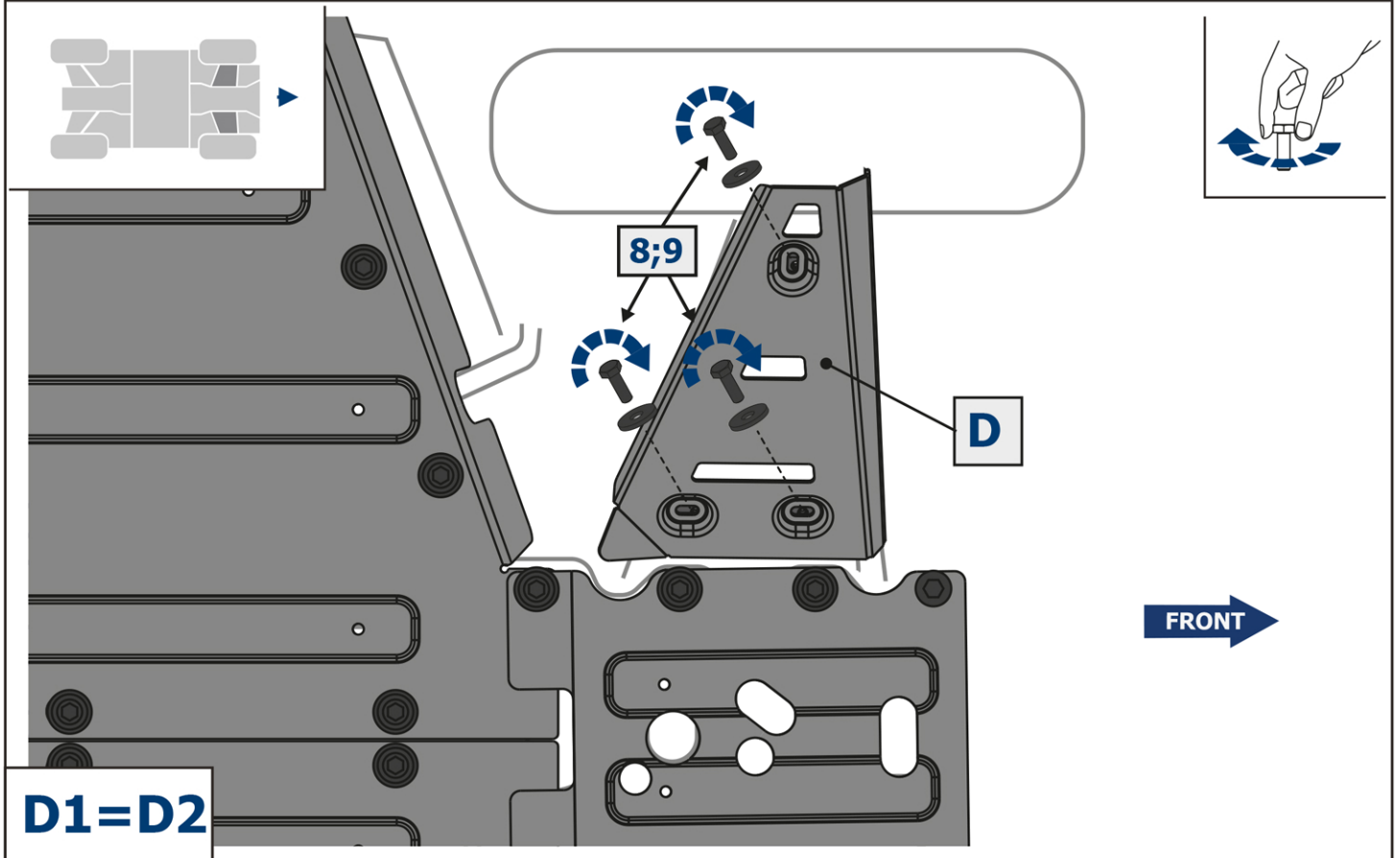
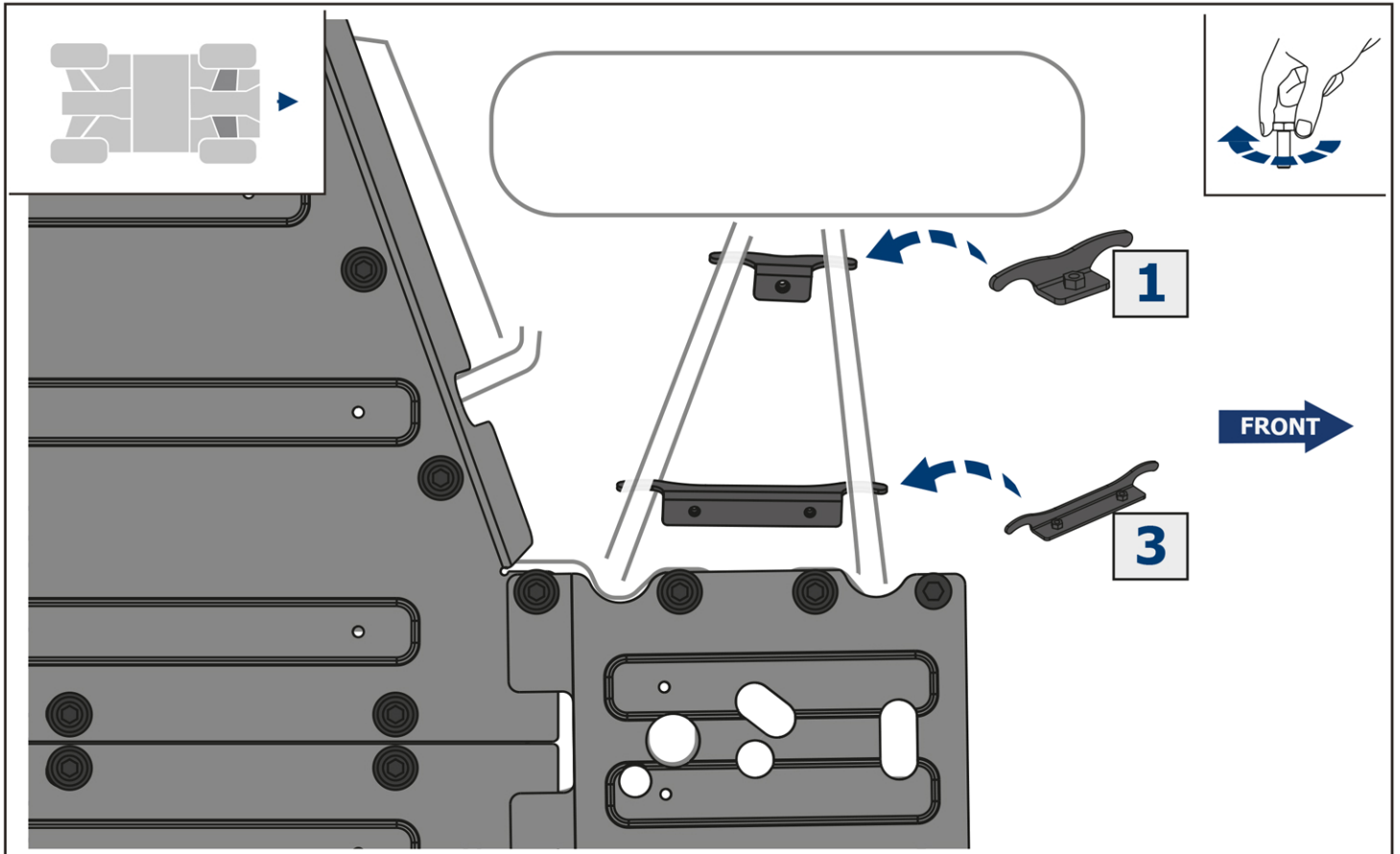

**D1=D2**



