

EN SKID PLATE INSTALLATION MANUAL

DE MONTAGEEINLEITUNG FÜR UNTERBODENSCHUTZSYSTEM



**For: Polaris Ranger 900/1000 (2018- )**

2444.7448.1-4



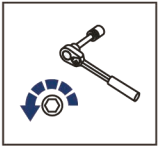

**EN Regular fasteners**  
**DE Normale Befestigung**

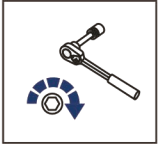

**EN Regular fasteners**  
**DE Normale Befestigung**



**EN Screw a several turns**  
**DE Mit wenigen Umdrehungen befestigen**



**EN Loosen bolts**  
**DE Bolzen lockern**

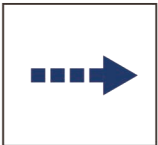

**EN Movement Arrow**  
**DE Bewegungsrichtung**

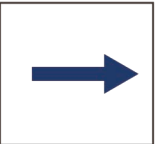



**EN Location / Position Arrow**  
**DE Anordnung / Positionsrichtung**

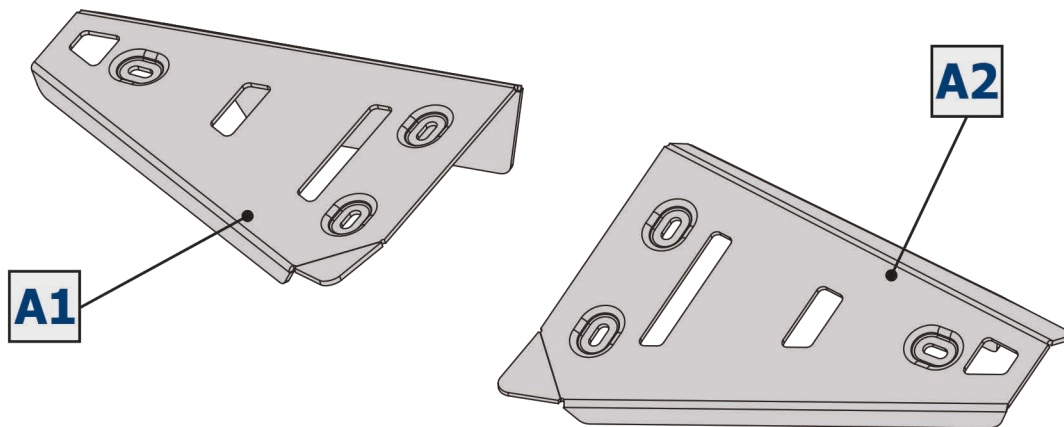

**EN Screw Arrow**  
**DE Drehrichtung**

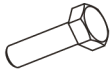

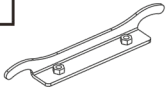
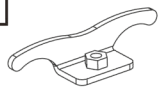
<b>1</b>  M8x25      x6	<b>2</b>  Ø8      x6	<b>3</b>  x2	<b>4</b>  x2
--	---	---	---

