

EN SKID PLATE INSTALLATION MANUAL

DE MONTAGEEINLEITUNG FÜR UNTERBODENSCHUTZSYSTEM



For: Polaris Ranger 570 (2017-)

2444.7440.1



WWW.RIVAL4X4.COM

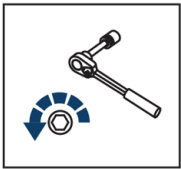

EN Regular fasteners
DE Originale montageteile

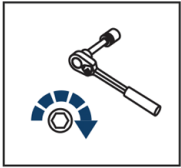

EN Regular fasteners
DE Originale montageteile



EN Screw a several turns
DE Für wenigen Umdrehungen befestigen



EN Loosen bolts
DE Bolzen lockern

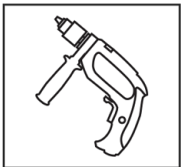

EN Drill
DE Bohrer

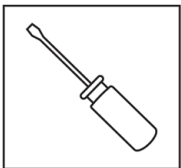

EN Screwdriver
DE Schraubenzieher

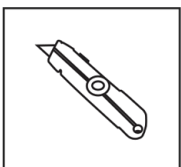

EN Office Knife
DE Büromesser

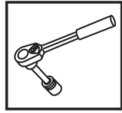



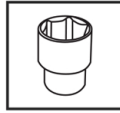

EN Ratchet
DE Ratsche

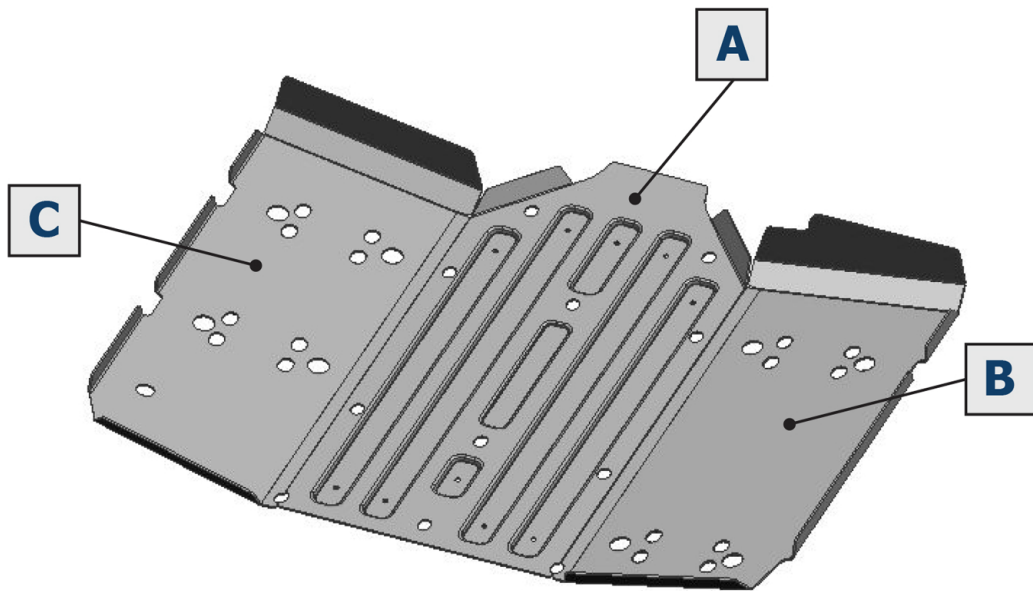

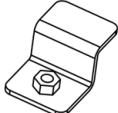
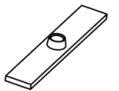
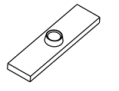
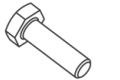
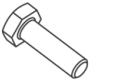
S - 10;
S - 13



1  x4	2  x1	3  M8x90/45 x4	4  M8x60/30 x4	5  M6x25 x11	6  M8x25 x25
7  Ø8 x8	8  Ø6 x11	9  Ø8 x17			

