

EN **SKID PLATE INSTALLATION MANUAL**

DE **MONTAGEEINLEITUNG FÜR UNTERBODENSCHUTZSYSTEM**



**For: Polaris Ranger 570 (2017- )**

2444.7440.1-5



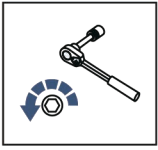

**EN Regular fasteners**  
**DE Normale Befestigung**

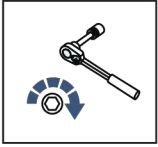

**EN Regular fasteners**  
**DE Normale Befestigung**

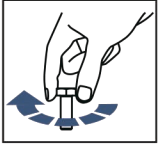

**EN Screw a several turns**  
**DE Mit wenigen Umdrehungen befestigen**

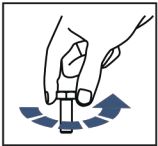

**EN Loosen bolts**  
**DE Bolzen lockern**

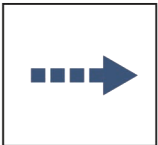

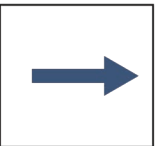

**EN Movement Arrow**  
**DE Bewegungsrichtung**





**EN Location / Position Arrow**  
**DE Anordnung / Positionsrichtung**

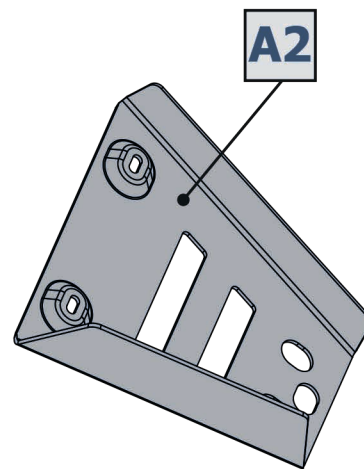
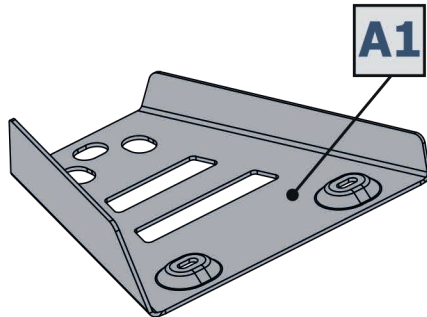

**EN Screw Arrow**  
**DE Drehrichtung**

 <p>EN Ratchet DE Ratsche</p>	 <p>S - 10; S - 13</p>	 <p>EN Office Knife DE Büromesser</p>
--	---	--

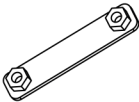
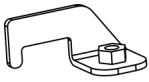
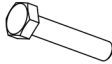

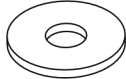
<p><b>1</b></p>  <p>x2</p>	<p><b>2</b></p>  <p>x4</p>	<p><b>3</b></p>  <p>M8x25</p> <p>x6</p>	<p><b>4</b></p>  <p>Ø8</p> <p>x2</p>	<p><b>5</b></p>  <p>Ø8</p> <p>x6</p>	
---	---	--	---	---	--

