

EN SKID PLATE INSTALLATION MANUAL

DE MONTAGEEINLEITUNG FÜR UNTERBODENSCHUTZSYSTEM



**For: BRP Defender 2020 HD10/MAX,
HD10/6X6/PRO (DPS, XT, XT-P, MAX DPS, MAX XT (2020 -))**

2444.7294.1

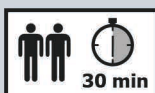

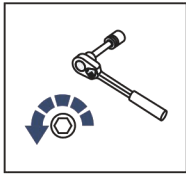

EN Regular fasteners
DE Schraube herausdrehen

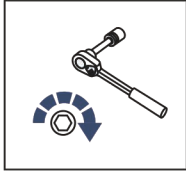

EN Regular fasteners
DE Schraube eindrehen und festziehen

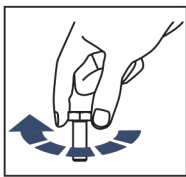

EN Screw a several turns
DE Schraube wenige Umdrehungen eindrehen

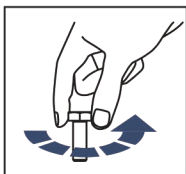

EN Loosen bolts
DE Schraube wenige Umdrehungen lösen

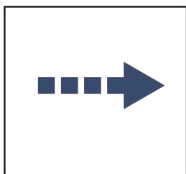

EN Movement Arrow
DE Bewegungsrichtung

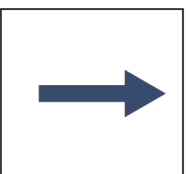

EN Location/Position Arrow
DE Blickrichtung / Postionsrichtung



EN Screw Arrow
DE Drehrichtung

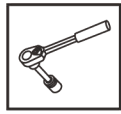

EN Ratchet
DE Ratsche

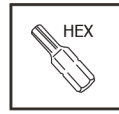



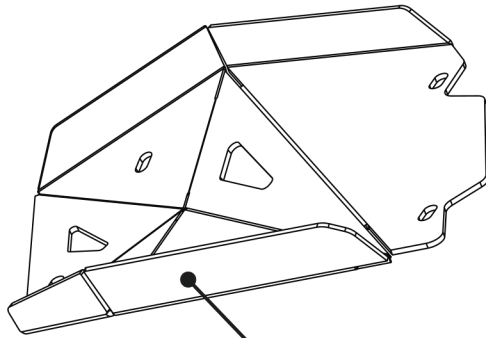



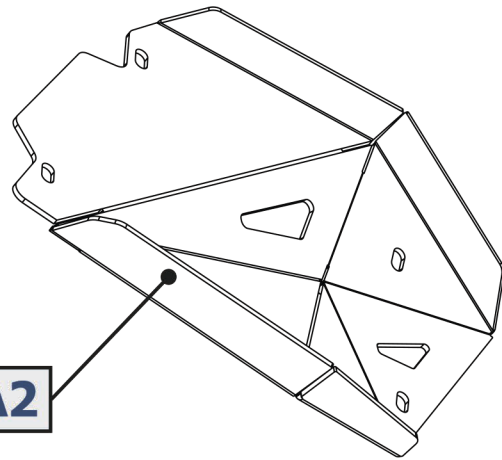

S - 5

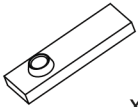

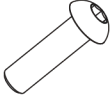
A1



A2

1		2		3		4		5		6	
M6	x2	M6x30	x2	M8x30	x6	Ø6	x2	Ø8	x6	Ø8	x10
7		8									
M8	x6		x4								

