

EN BUMPER KIT INSTALLATION MANUAL

DE MONTAGEEINLEITUNG FÜR STOBFÄNGER-KIT



For: Can-Am Maverick X3 (2017-)

2444.7269.1



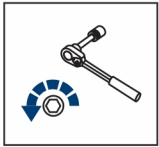

EN Regular fasteners
DE Originale montageile

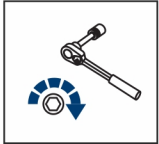

EN Regular fasteners
DE Originale montageile



EN Screw a several turns
DE Für wenigen Umdrehungen befestigen



EN Loosen bolts
DE Bolzen lockern

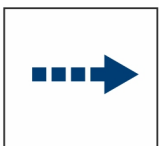

EN Movement Arrow
DE Bewegungsrichtung

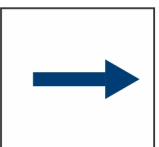



EN Location/Position Arrow
DE Anordnung/Positionsrichtung

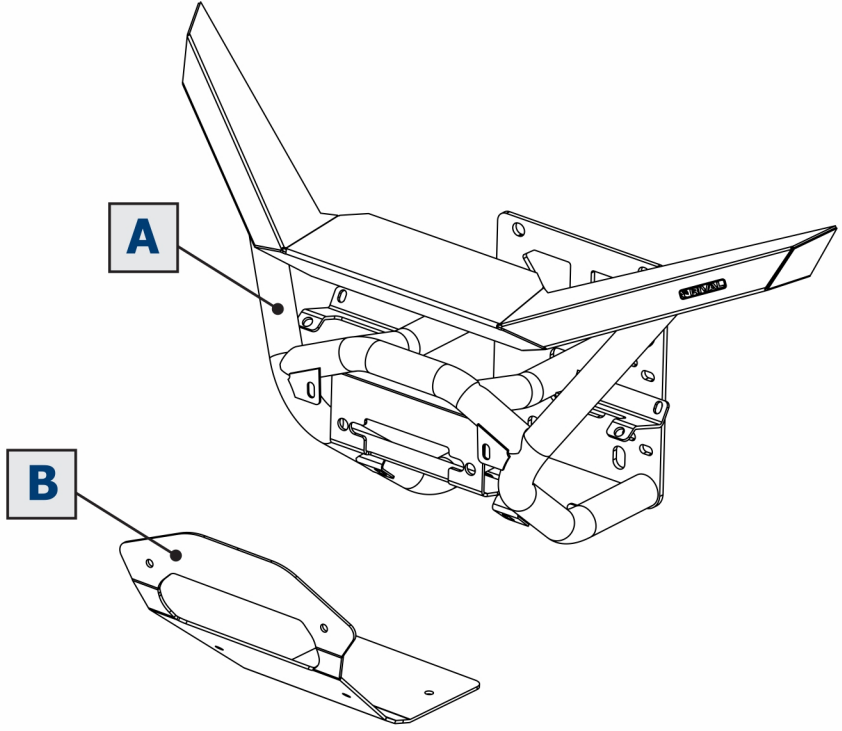

EN Screw Arrow
DE Drehungsrichtung

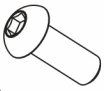

1		2		3	
M6x16	x6	M6	x6	Ø6	x6

