

EN

SIDE STEP PROTECTION INSTALLATION MANUAL

DE

MONTAGEEINLEITUNG FÜR SEITENSTUFENSCHUTZ



For: Yamaha Wolverine RMAX4 1000 (2021-)

2444.7179.1



WWW.RIVAL4X4.COM

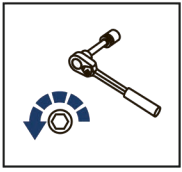

EN Regular fasteners
DE Originale montageteile

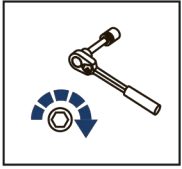

EN Regular fasteners
DE Originale montageteile

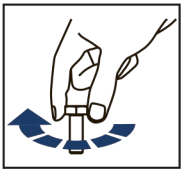

EN Screw a several turns
DE Für wenigen Umdrehungen befestigen

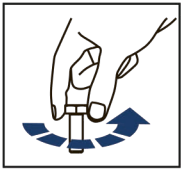

EN Loosen bolts
DE Bolzen lockern

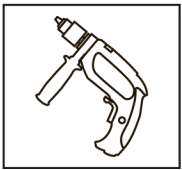

EN Drill
DE Bohrer

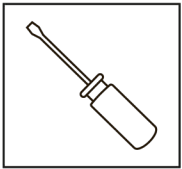

EN Screwdriver
DE Schraubenzieher

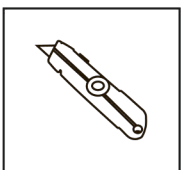

EN Office Knife
DE Büromesser

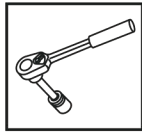



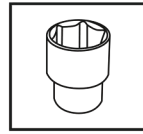



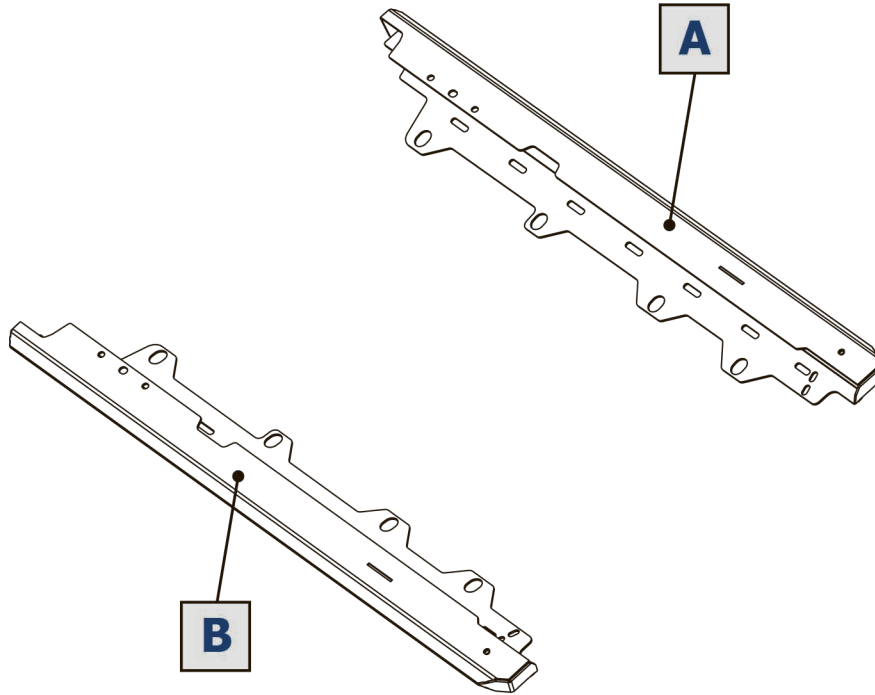



EN Ratchet

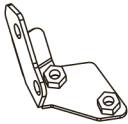

S - 10;
S - 14;
S - 17;
S - 19

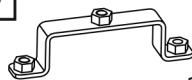
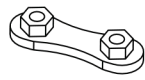
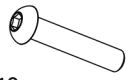

1  M6x25 x8	2  M8x20 x8	3  M8x25 x4	4  ø8 x10	5  ø6 x8	6  x8
7  x1	8  x1	9  x2	10  x2	11  M8x40 x2	12  ø8 x4

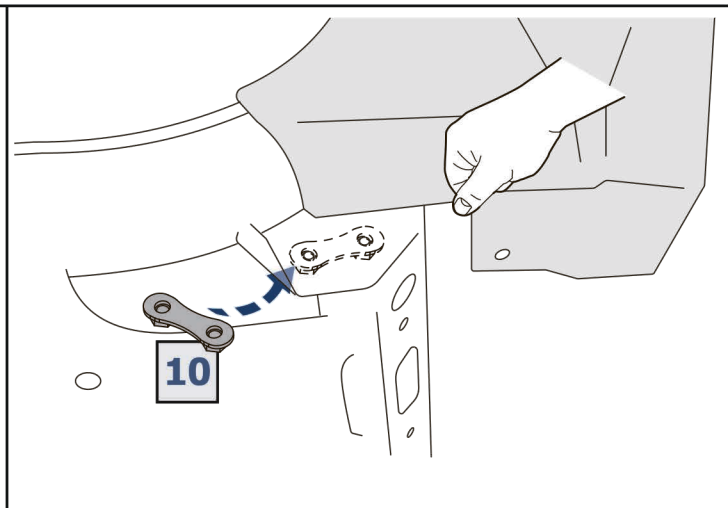
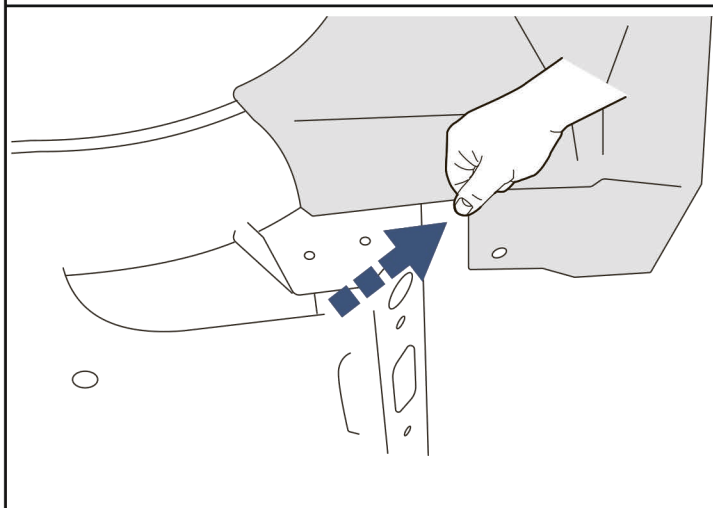
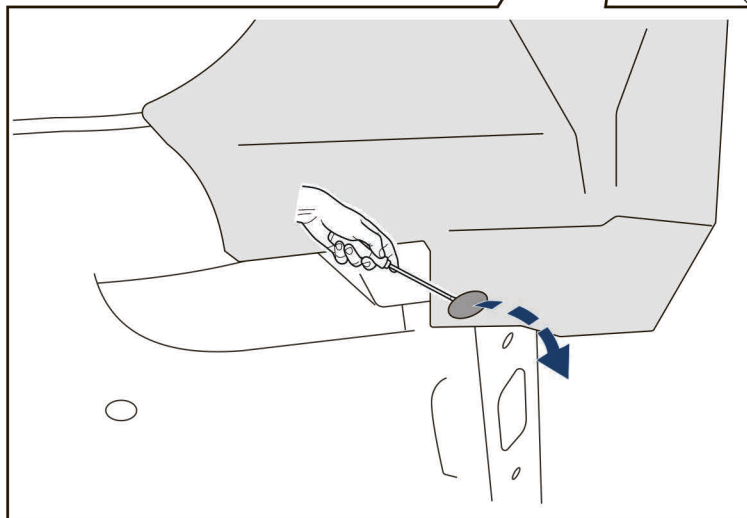
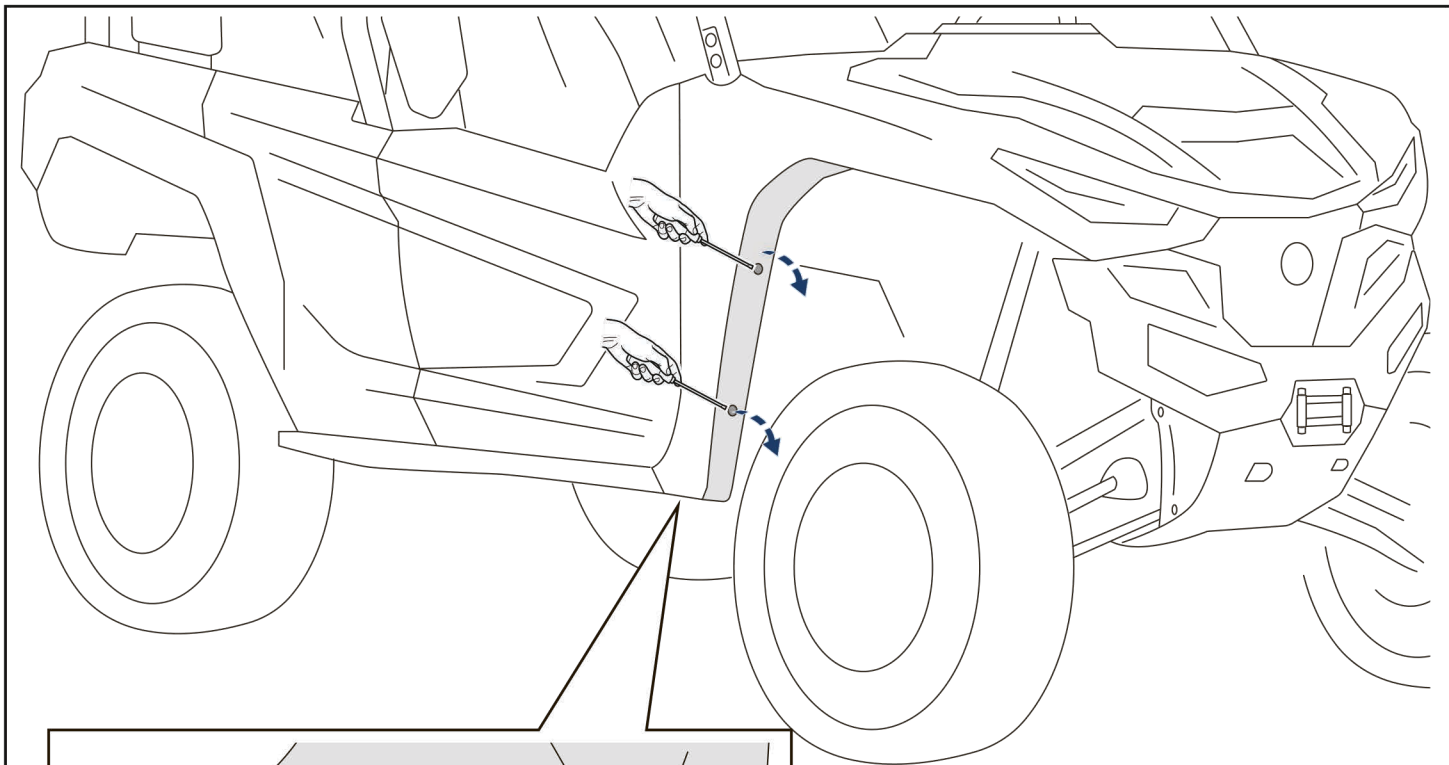

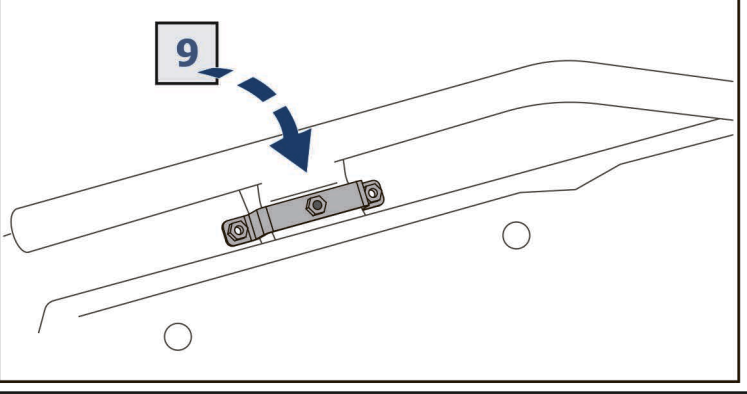
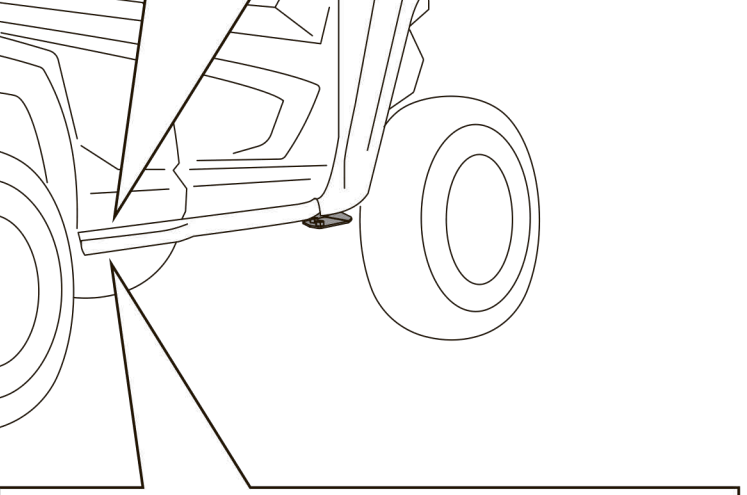
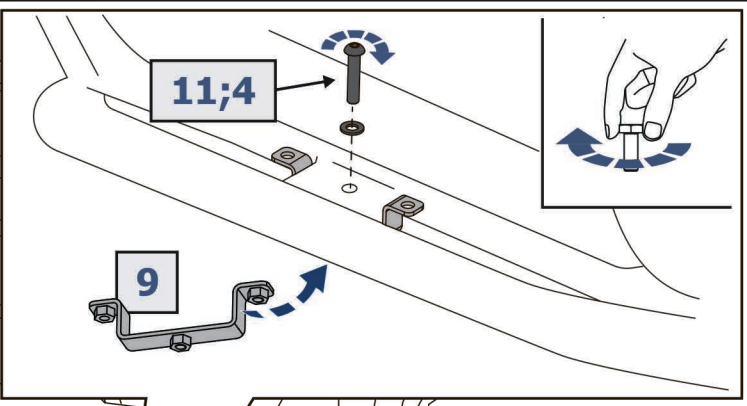
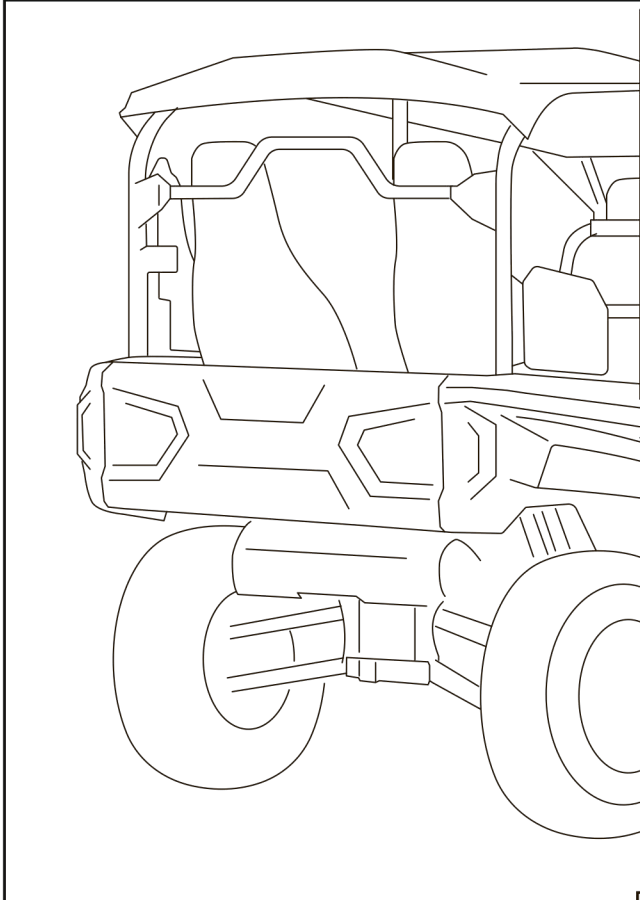
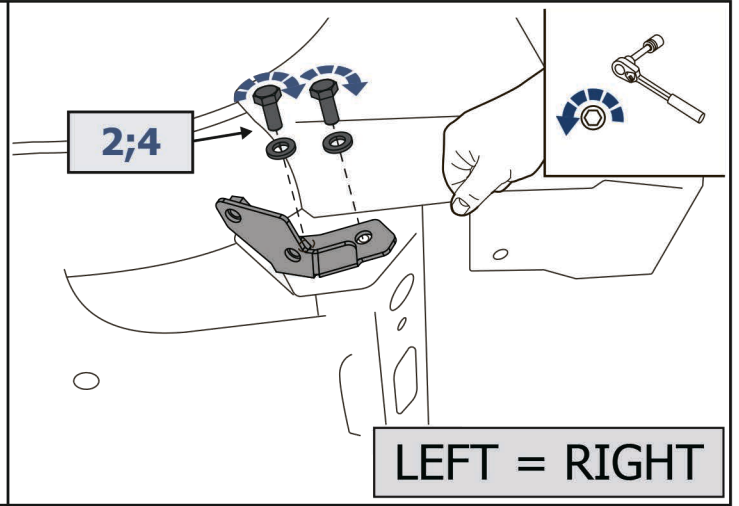
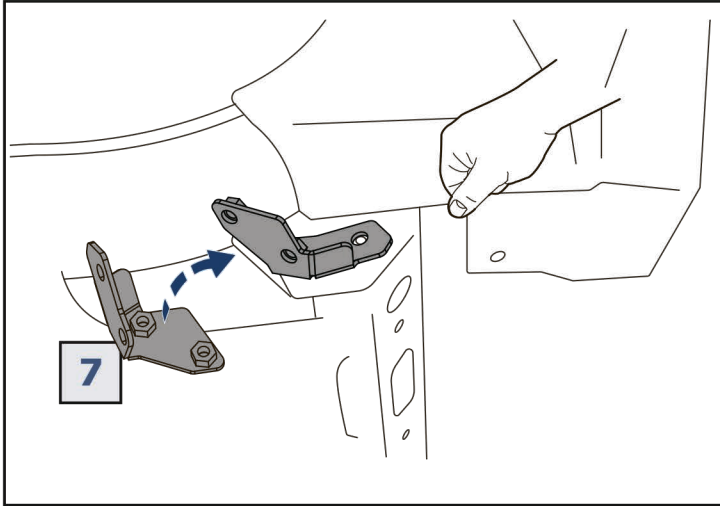

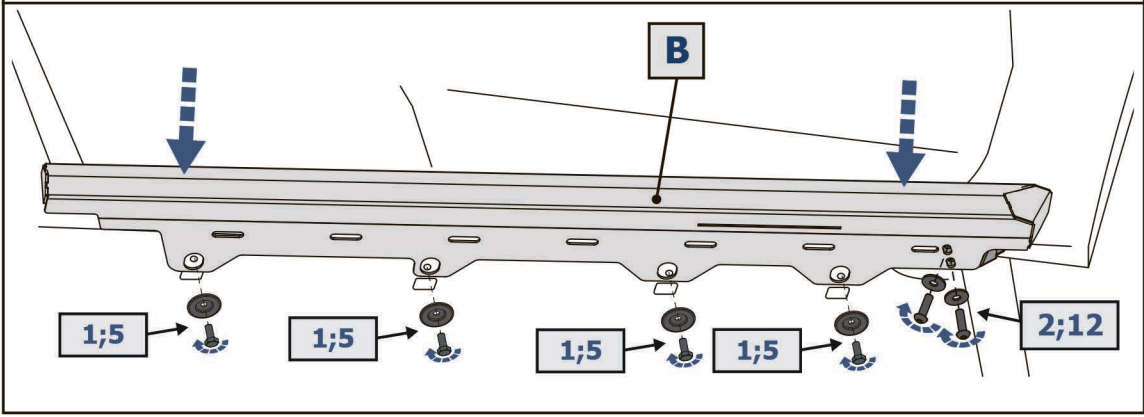
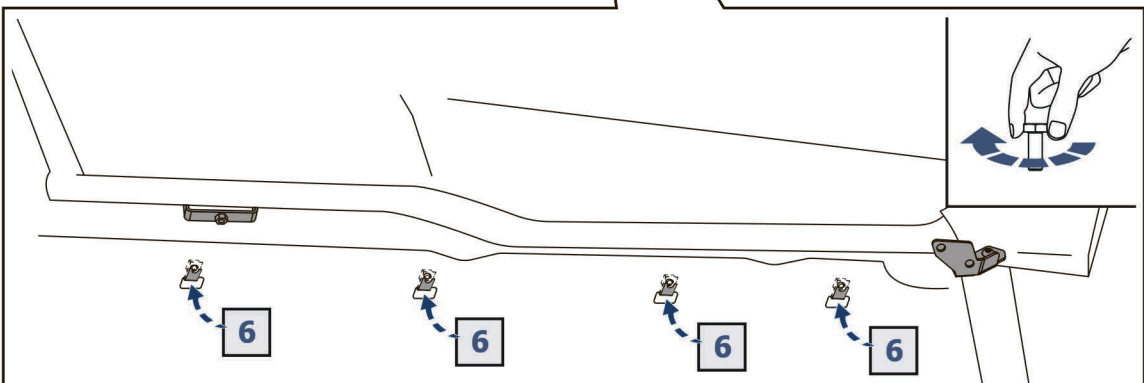
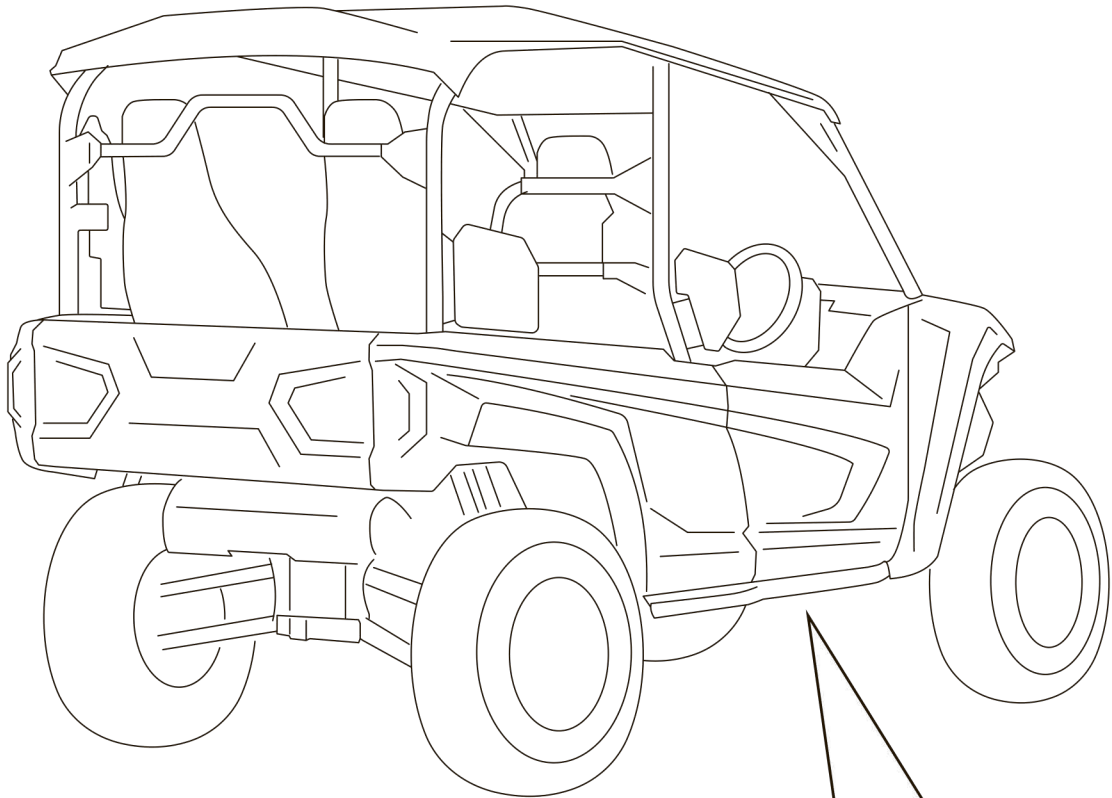

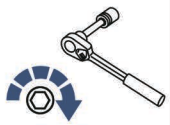

M8=24 Nm

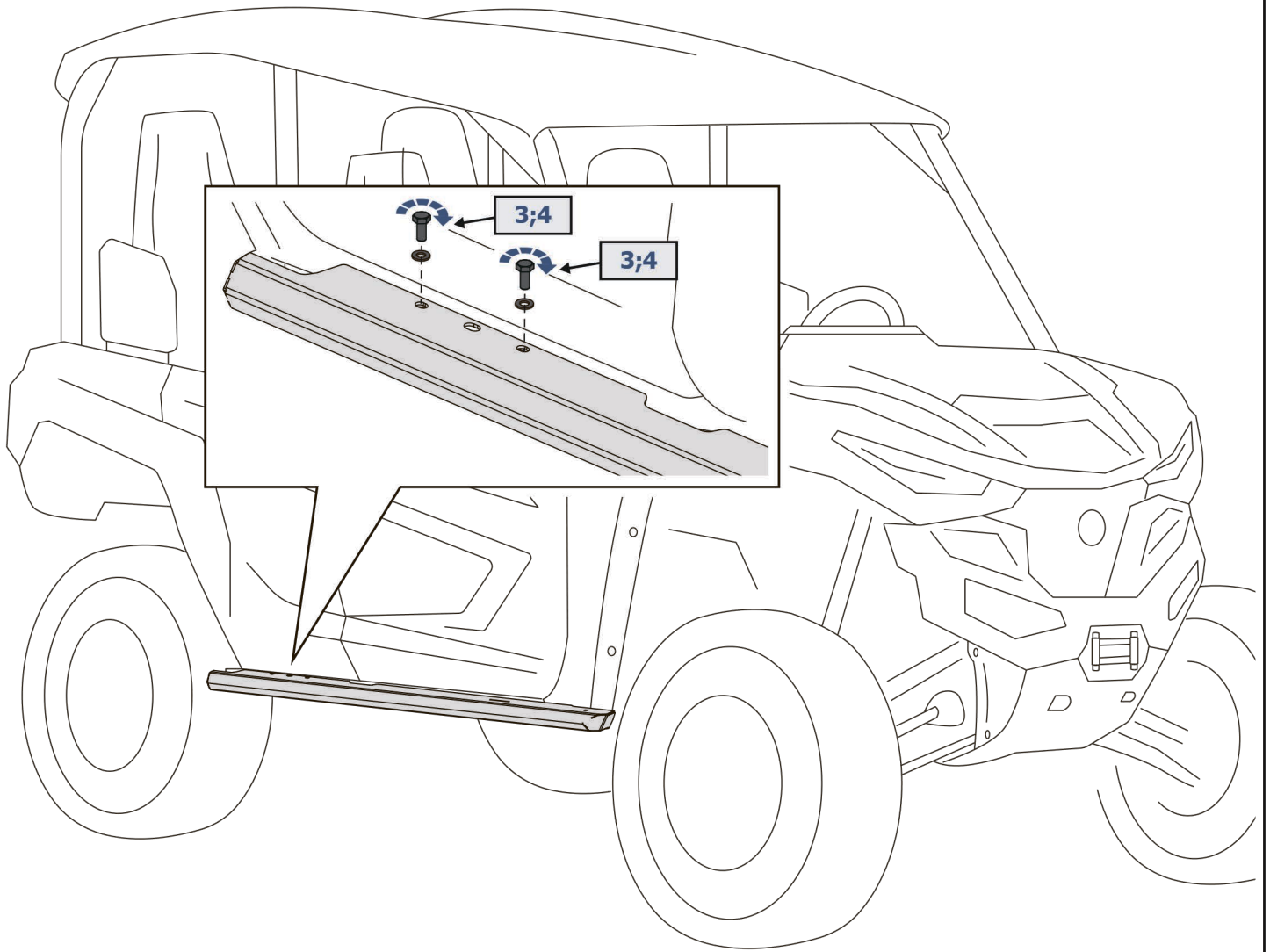

LEFT = RIGHT

