

EN SKID PLATE INSTALLATION MANUAL

DE MONTAGEANLEITUNG FÜR UNTERBODENSCHUTZ SYSTEM

RU ИНСТРУКЦИЯ ПО УСТАНОВКЕ ЗАЩИТЫ АРОК



**For: Yamaha Wolverine RMAX (2021- )**

2444.7165.1



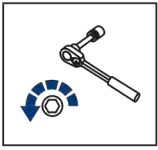

EN Regular fasteners  
DE Originale montageteile  
RU Штатный крепеж

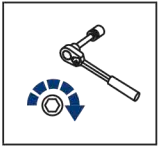

EN Regular fasteners  
DE Originale montageteile  
RU Штатный крепеж



EN Screw a several turns  
DE Für wenigen Umdrehungen befestigen  
RU Вкрутить на несколько оборотов



EN Loosen bolts  
DE Bolzen lockern  
RU Выкрутить на несколько оборотов

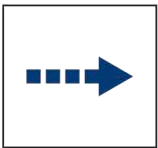

EN Movement Arrow  
DE Bewegungsrichtung  
RU Движение

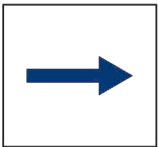





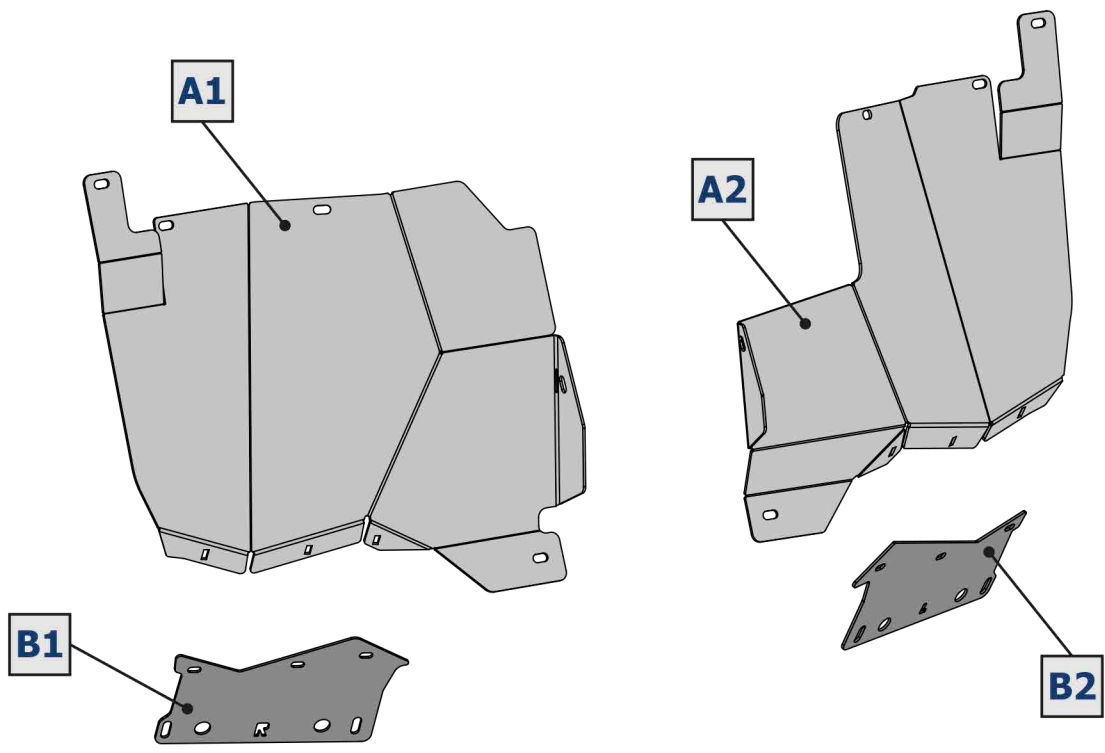

EN Location/Position Arrow  
DE Anordnung/Positionsrichtung  
RU Расположение



EN Screw Arrow  
DE Drehungsrichtung  
RU Поворот

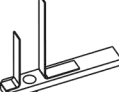

<b>1</b>  M6x16 x6	<b>2</b>  M6x25 x10	<b>3</b>  M6x55 x1	<b>4</b>  M8x30 x2	<b>5</b>  ø6 x22	<b>6</b>  ø8 x2
<b>7</b>  M6 x11	<b>8</b>  x2				

PRE-INSTALLATION: LAY OUT COMPONENTS AND COMPARE TO LIST AND IMAGES. IMAGES MAY NOT PORTRAY THE FULL DETAIL OR EXACT SHAPE OF THE PARTS; HOWEVER, THEY REPRESENT PARTS THAT HAVE SAME OR SIMILAR FUNCTION.

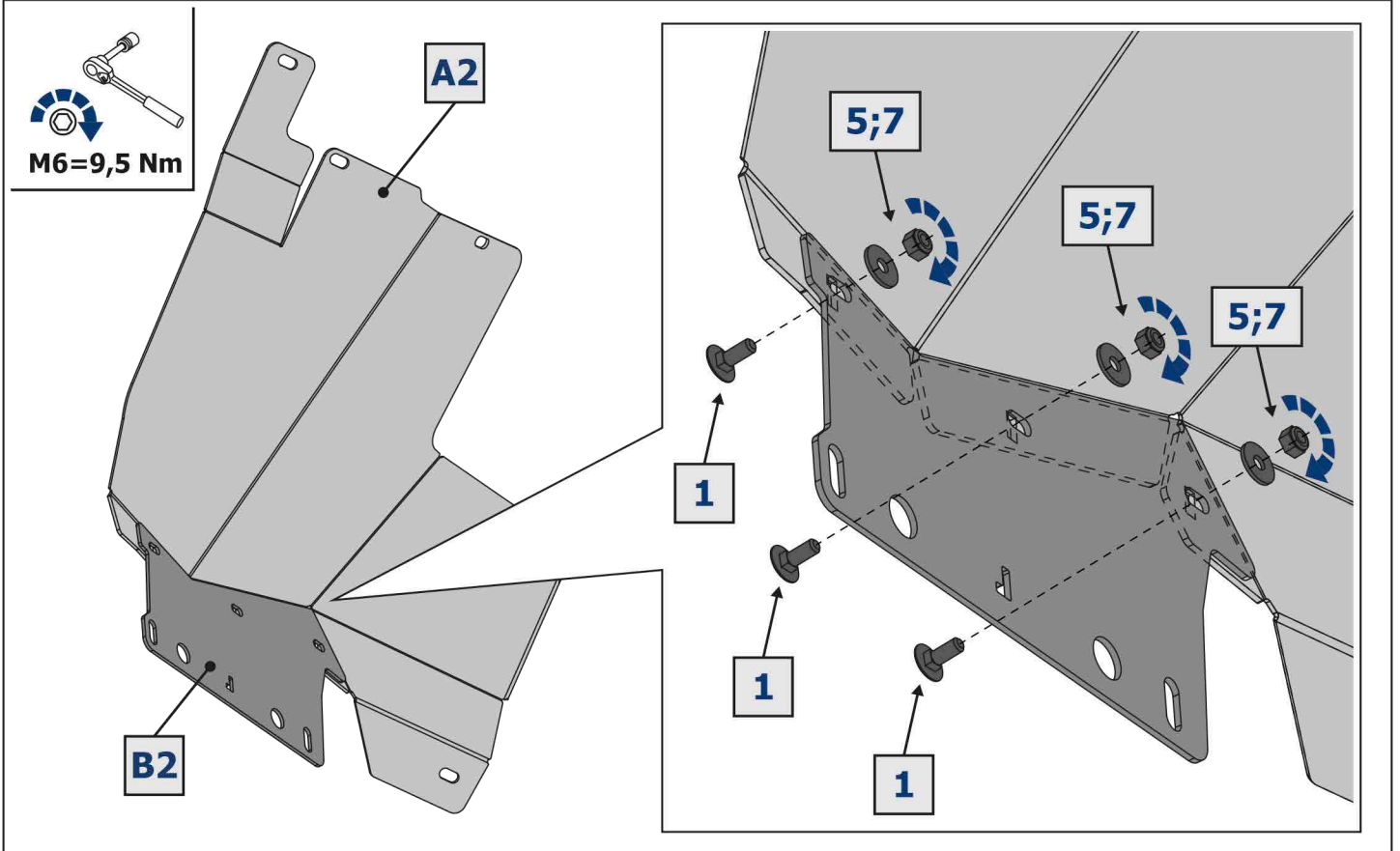
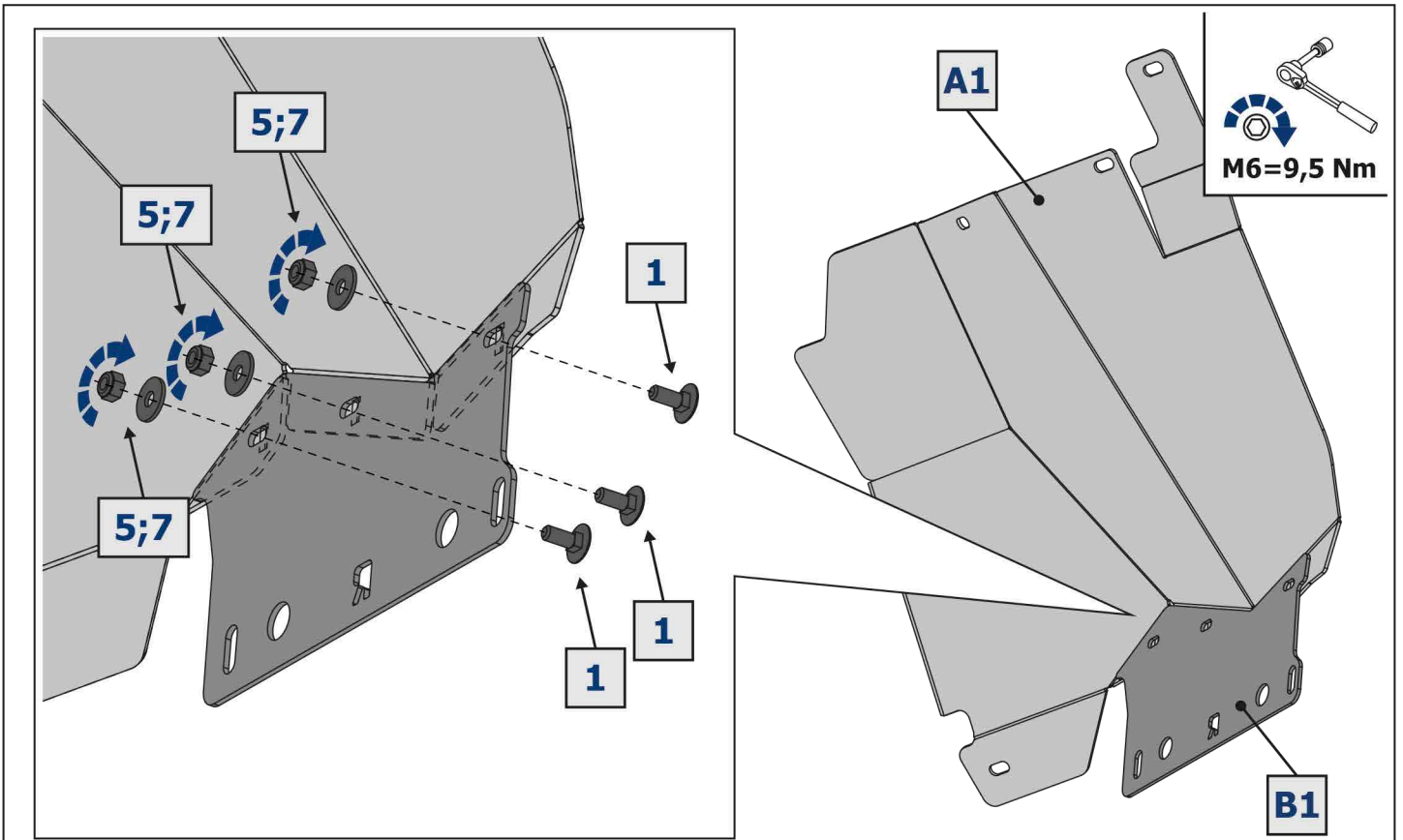

LEFT SIDE

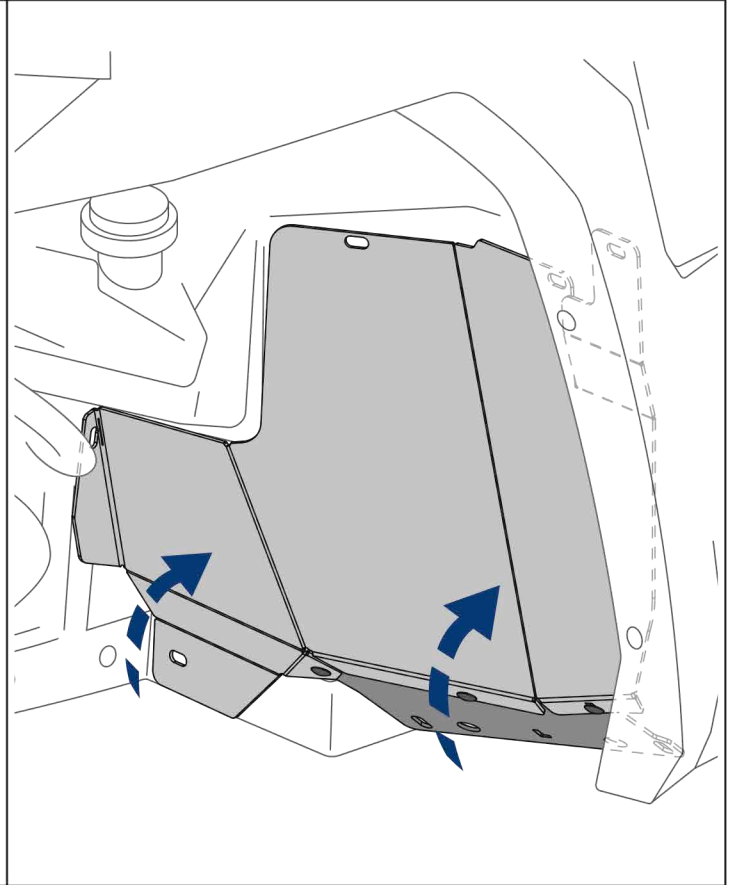
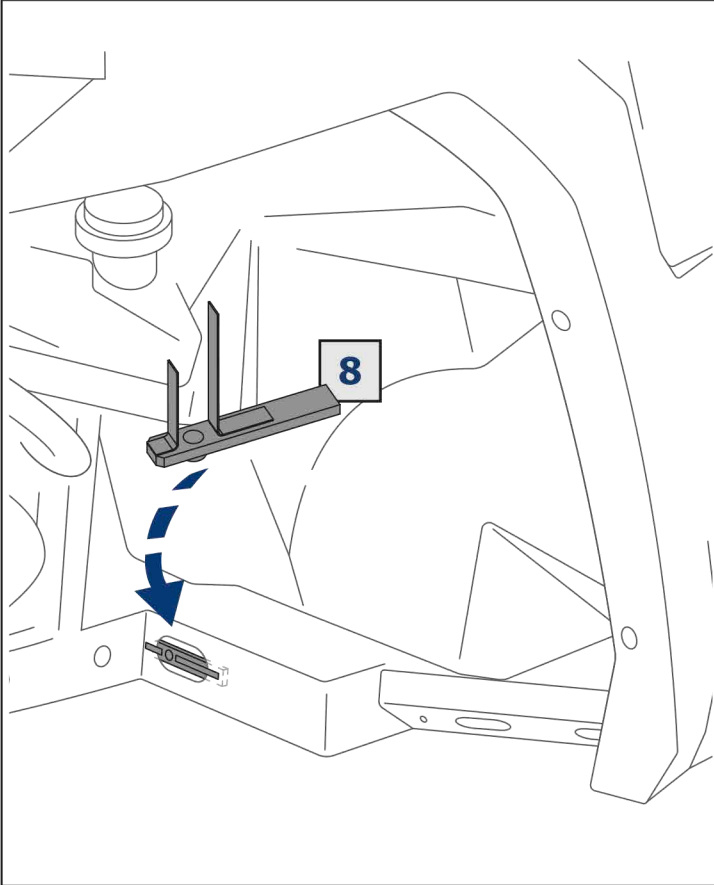
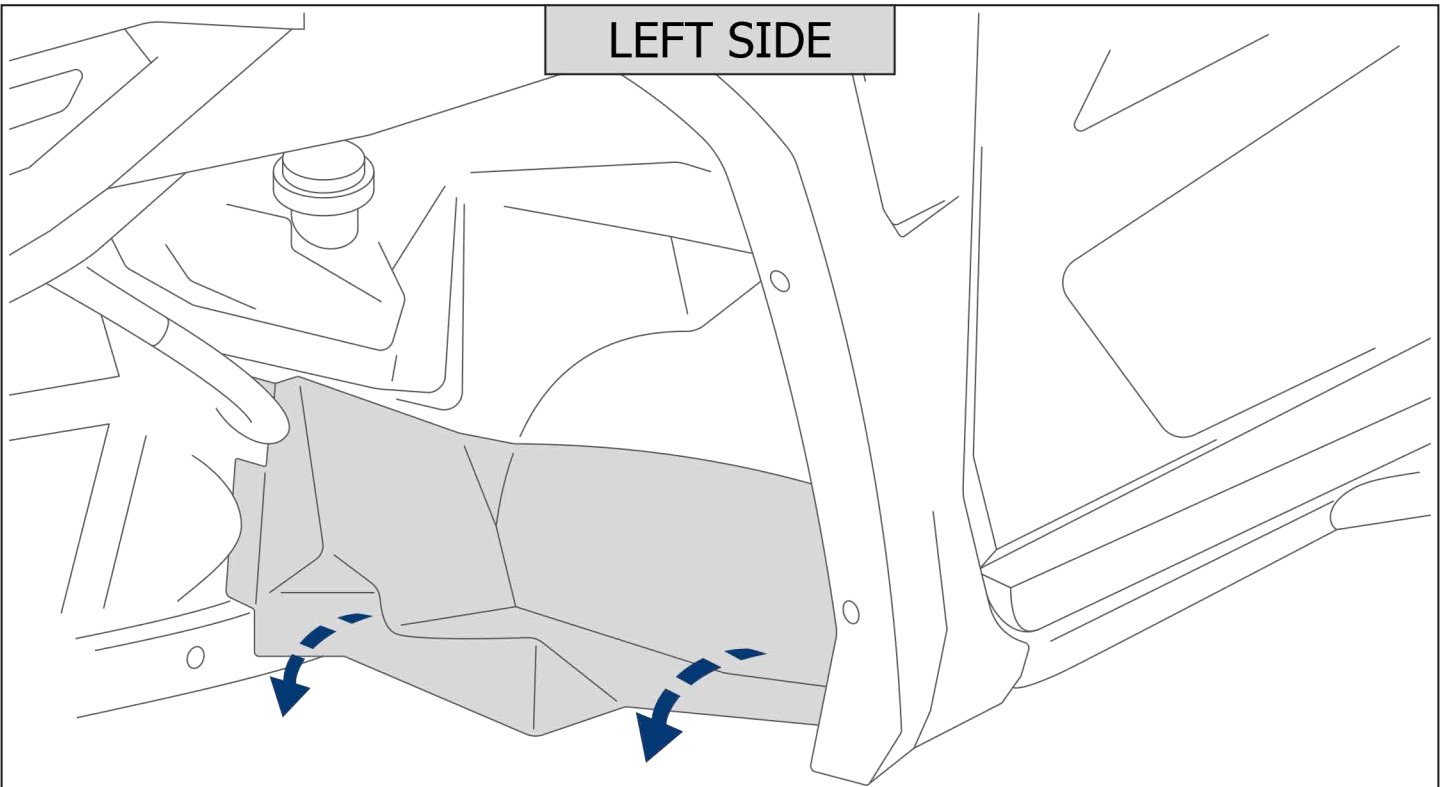

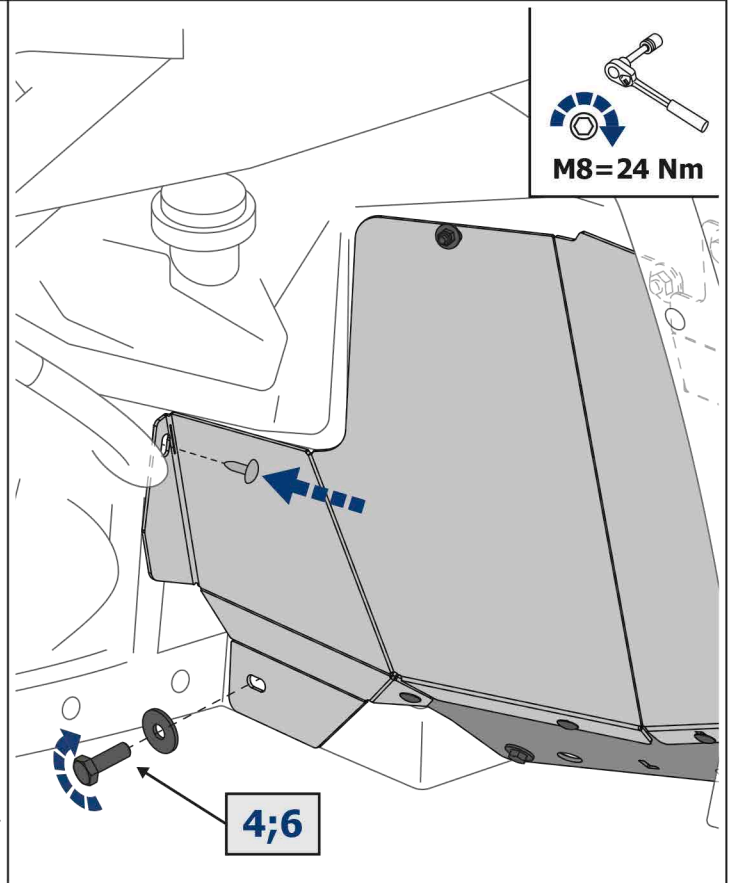
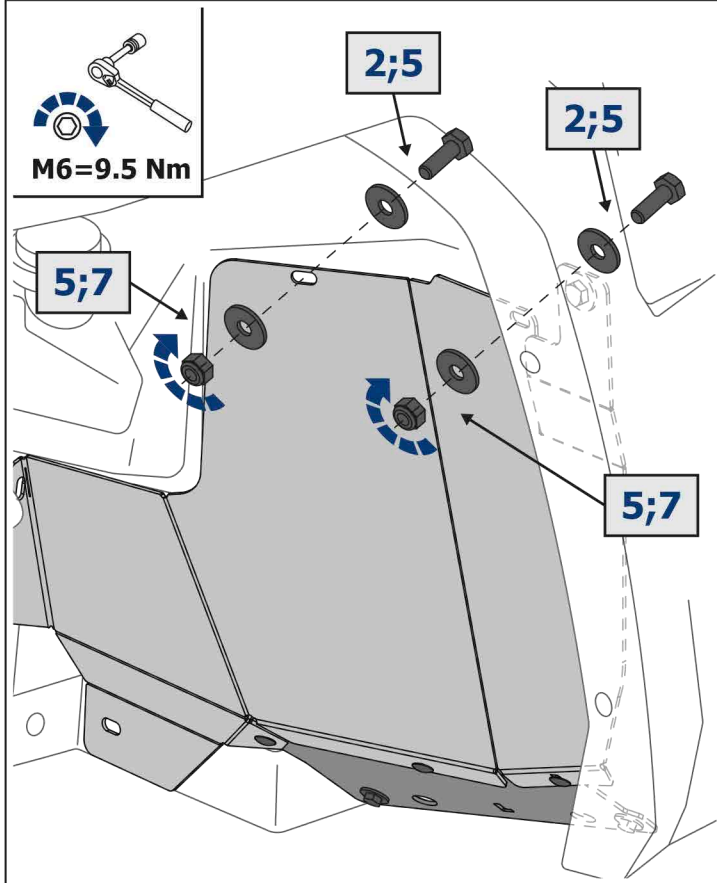
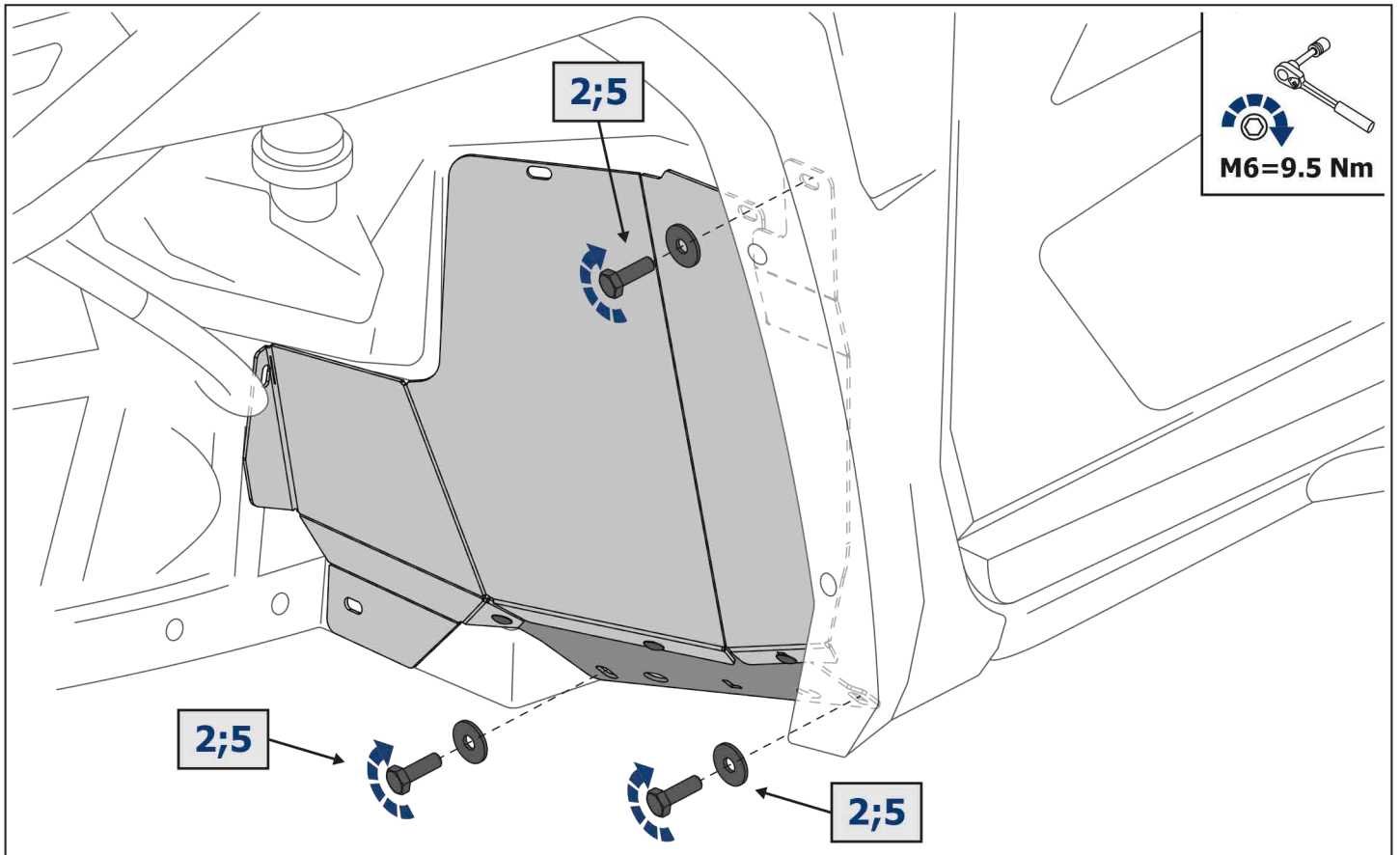

RIGHT SIDE

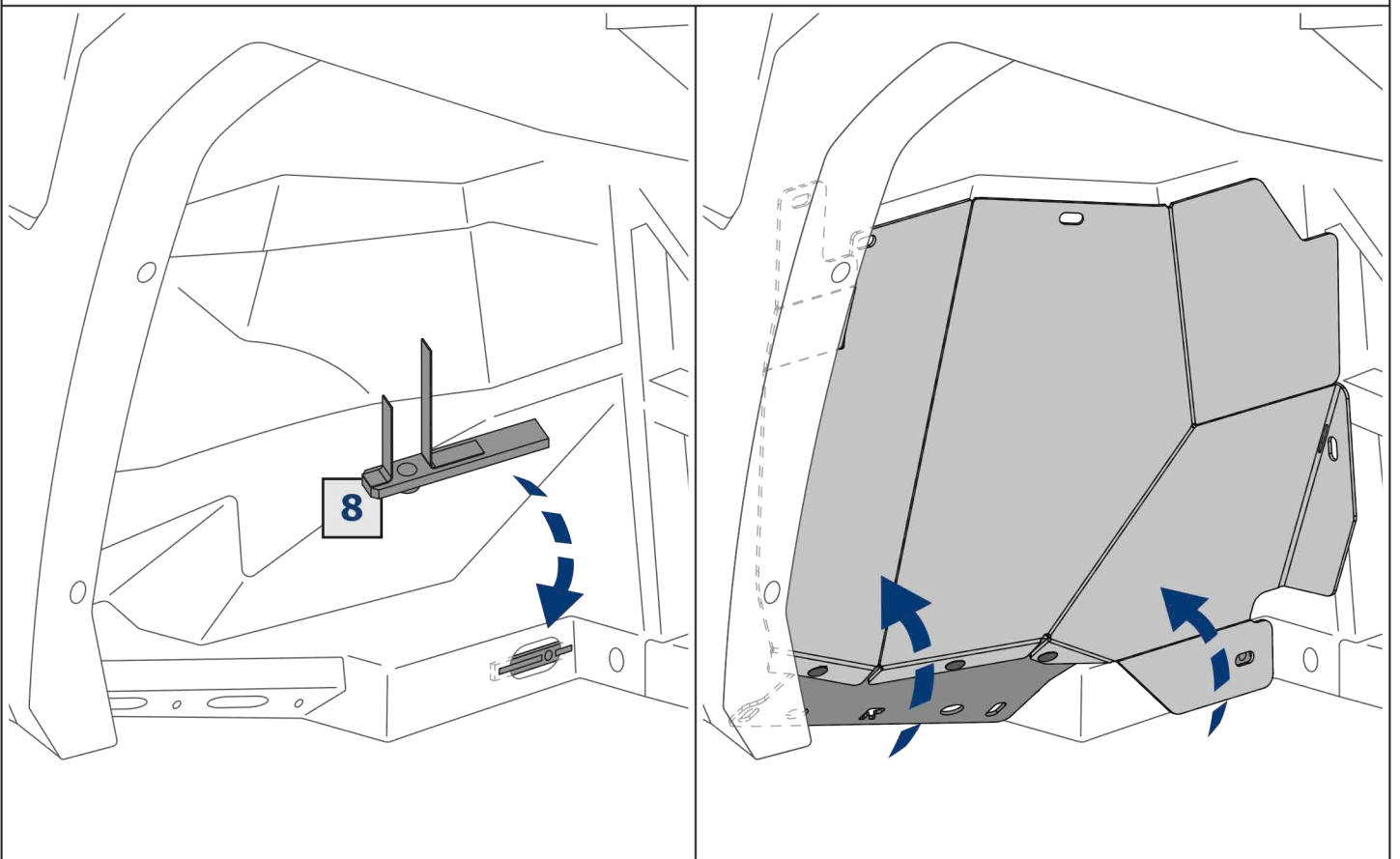
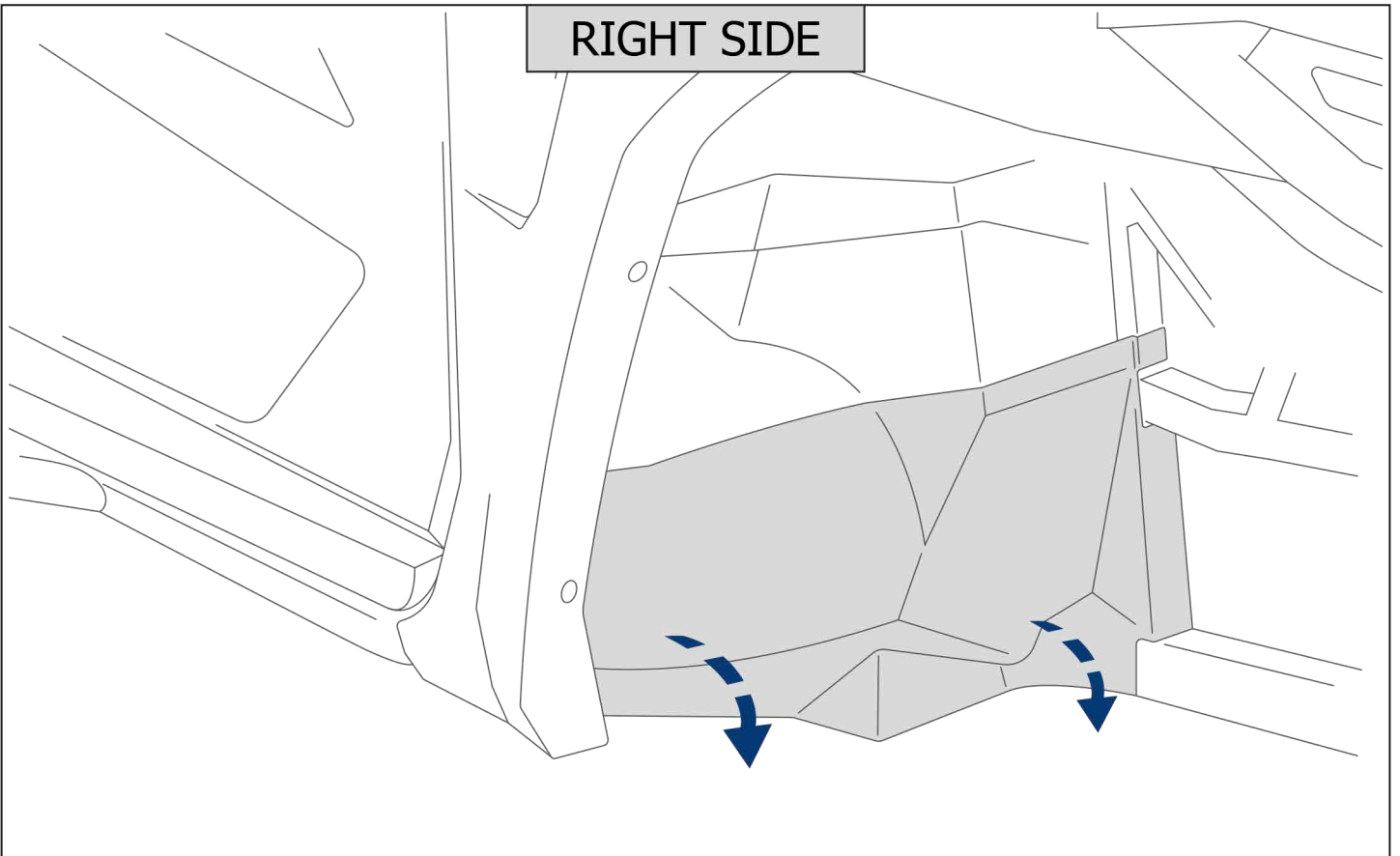

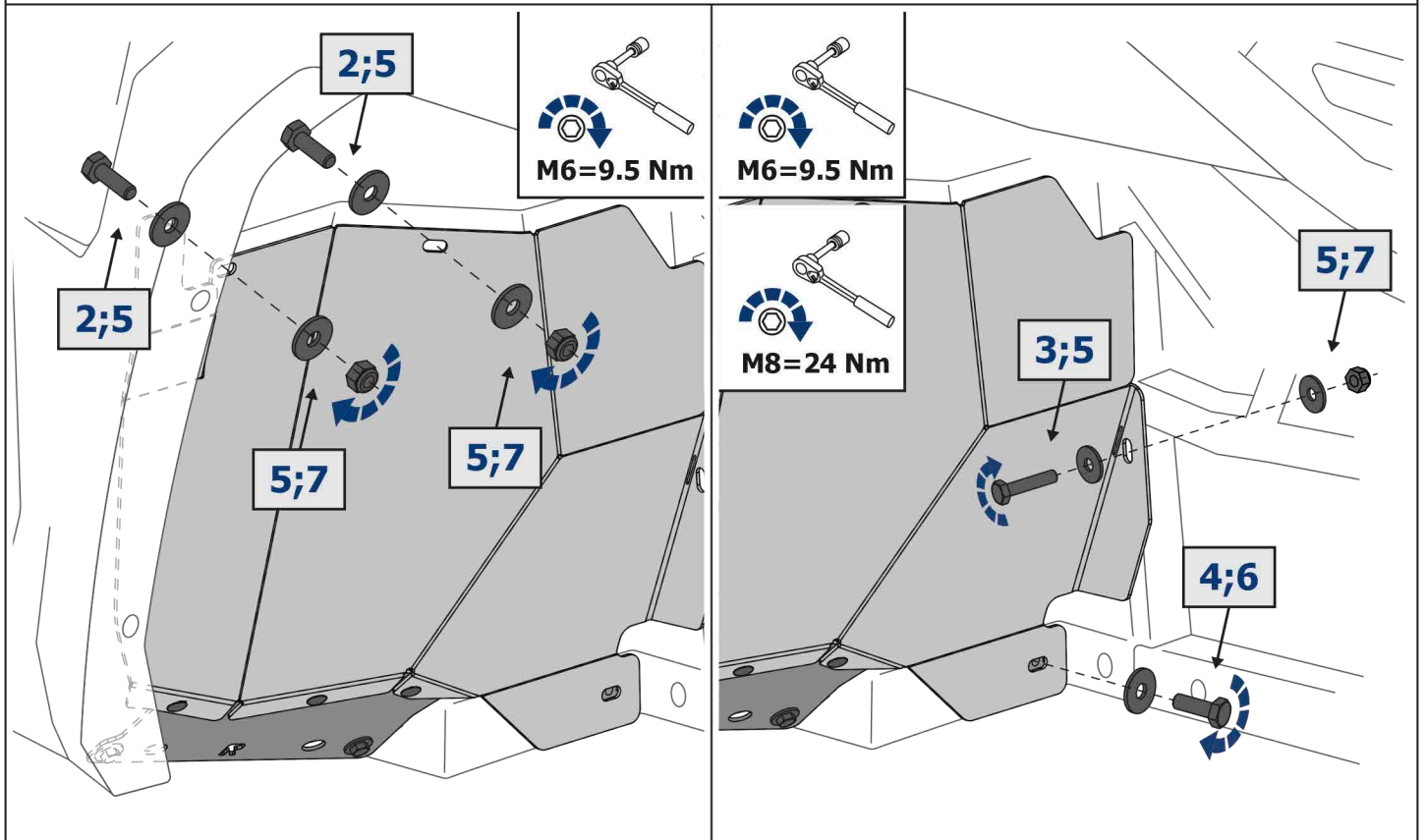
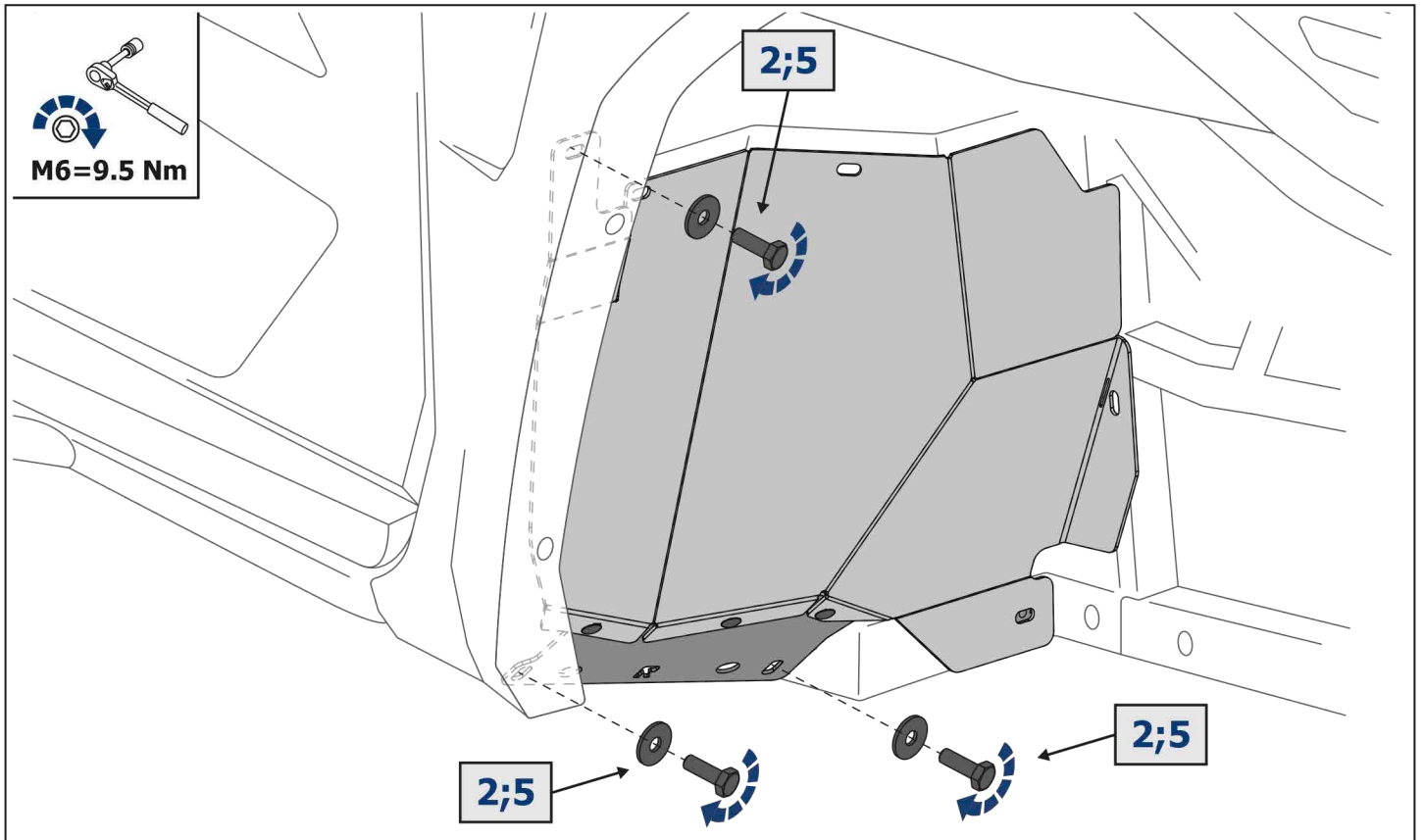

TIP: PERIODICALLY CHECK ALL HARDWARE AND RE-TIGHTEN IF NEEDED.