

EN **SKID PLATE INSTALLATION MANUAL**

DE **MONTAGEEINLEITUNG FÜR UNTERBODENSCHUTZSYSTEM**



For: Yamaha Grizzly 700 (2015-)

2444.7124.1-4



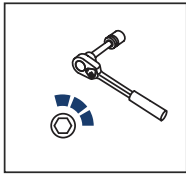

EN Regular fasteners
DE Schraube herausdrehen

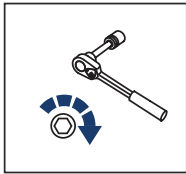

EN Regular fasteners
DE Schraube eindrehen und festziehen

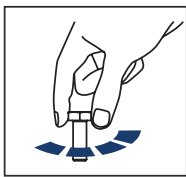

EN Screw a several turns
DE Schraube wenige Umdrehungen eindrehen

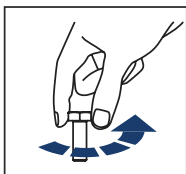

EN Loosen bolts
DE Schraube wenige Umdrehungen lösen

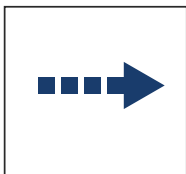

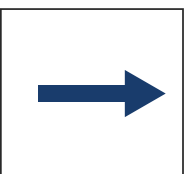

EN Movement Arrow
DE Bewegungsrichtung











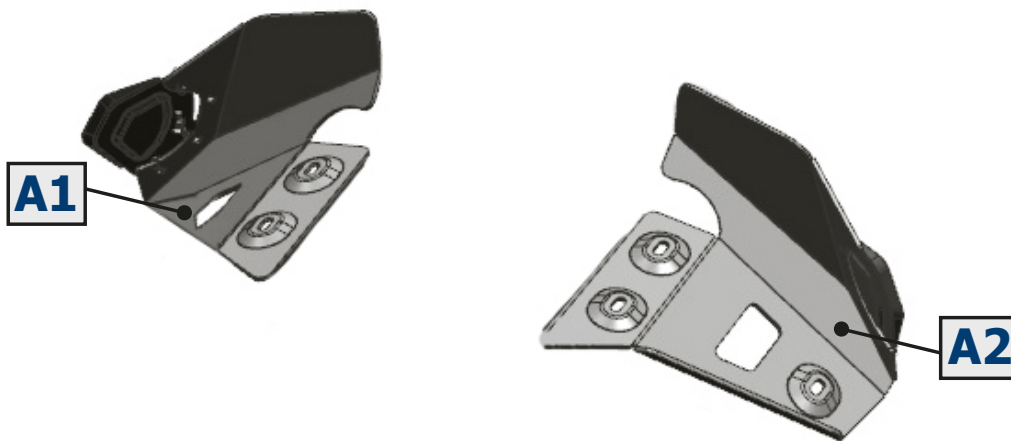

EN Location/Position Arrow
DE Blickrichtung / Postionsrichtung

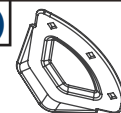

EN Screw Arrow
DE Drehrichtung

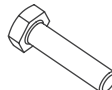
 <p>EN Ratchet DE Ratsche</p>	 <p>S - 10; S - 13</p>	 <p>EN Office Knife DE Büromesser</p>
--	---	--



<p>1</p>  <p>x2</p>	<p>2</p>  <p>x4</p>	<p>3(1)</p>  <p>x1</p>	<p>3(2)</p>  <p>x1</p>	<p>4</p>  <p>M6x16 x6</p>	<p>5</p>  <p>M8x25 x6</p>
<p>6</p>  <p>M6 x6</p>	<p>7</p>  <p>Ø6 x6</p>	<p>8</p>  <p>Ø6 x6</p>	<p>9</p>  <p>Ø8 x6</p>		

SCREW FORCE:
M6 - 10 Nm; M8 - 30 Nm

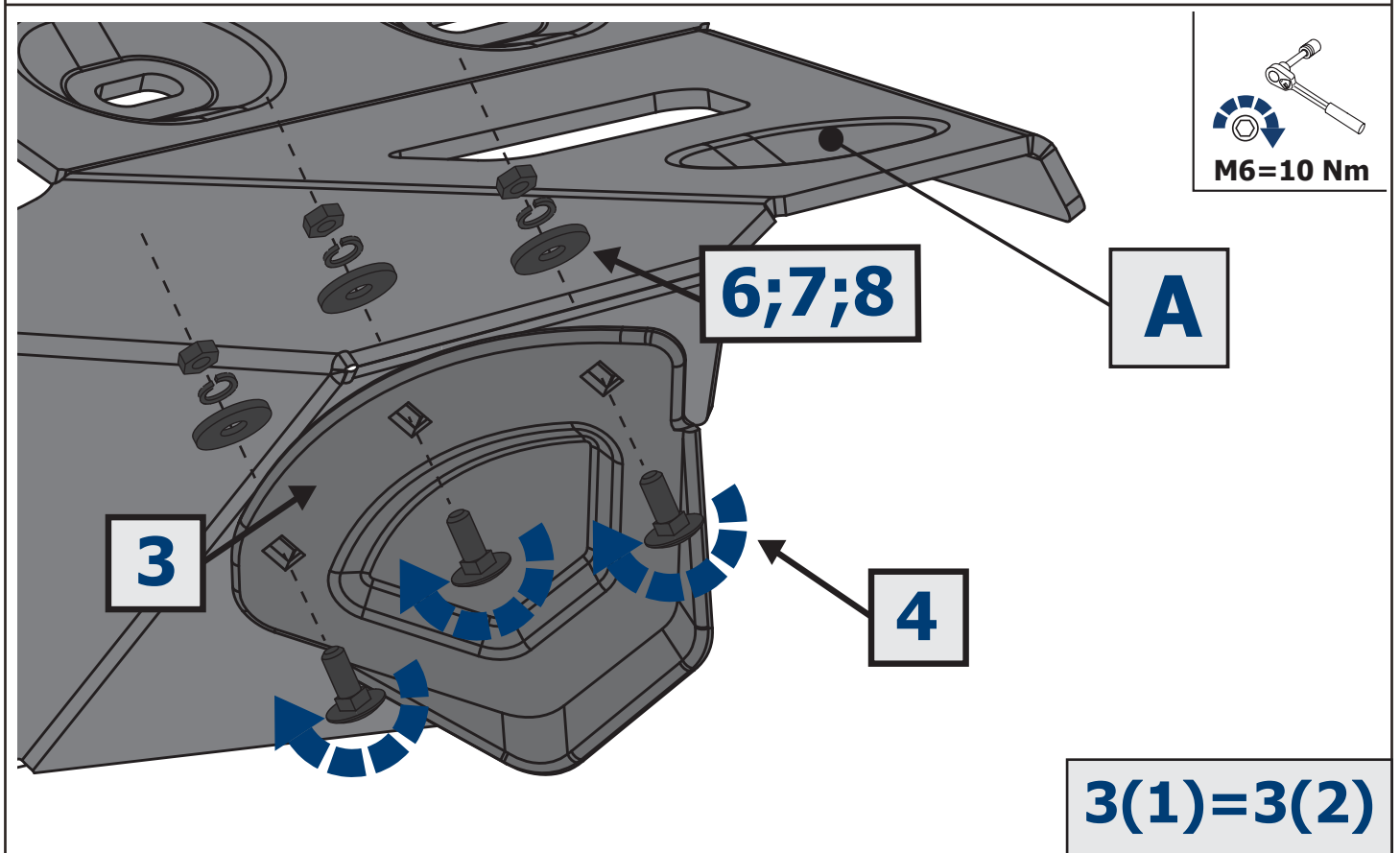
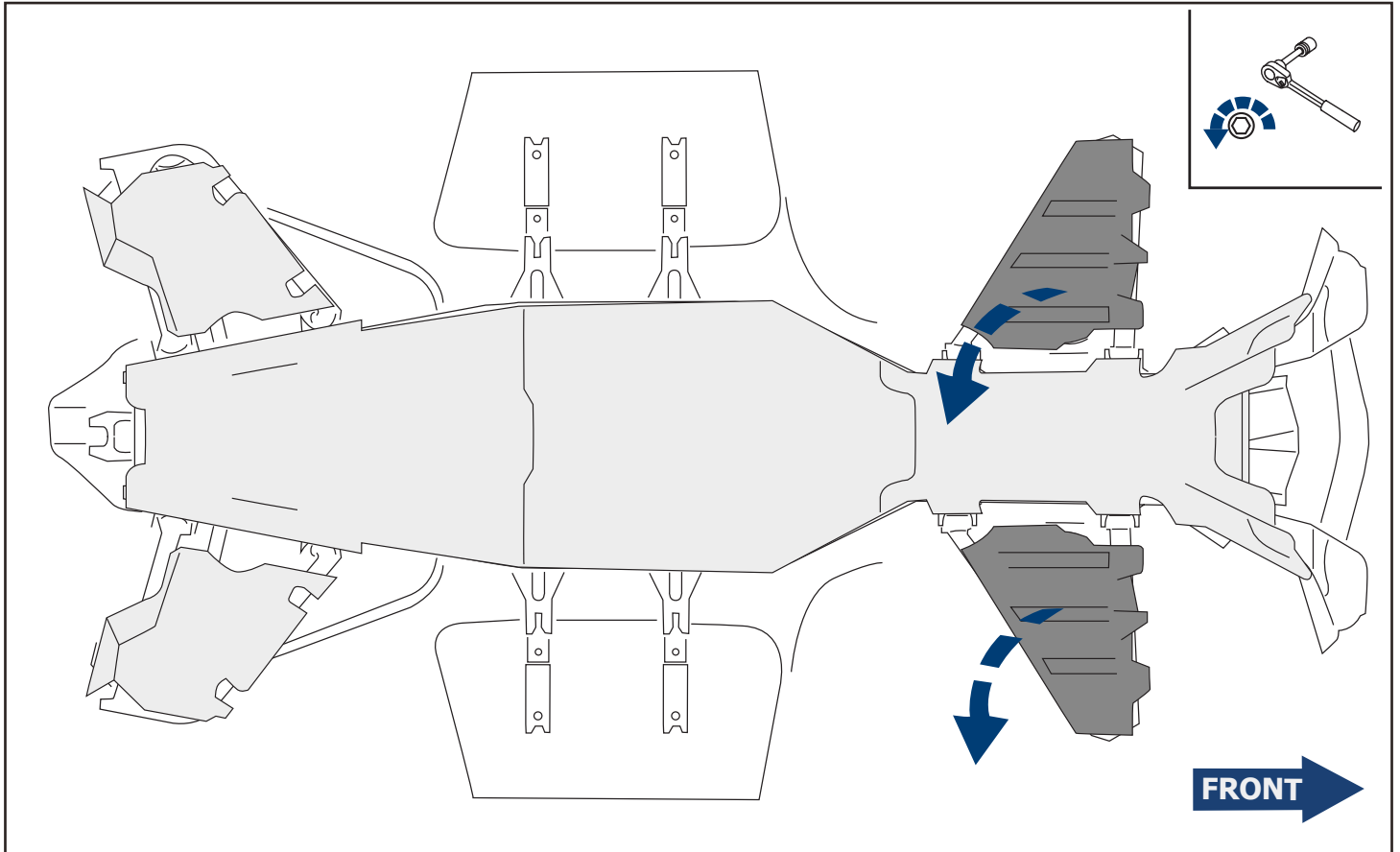

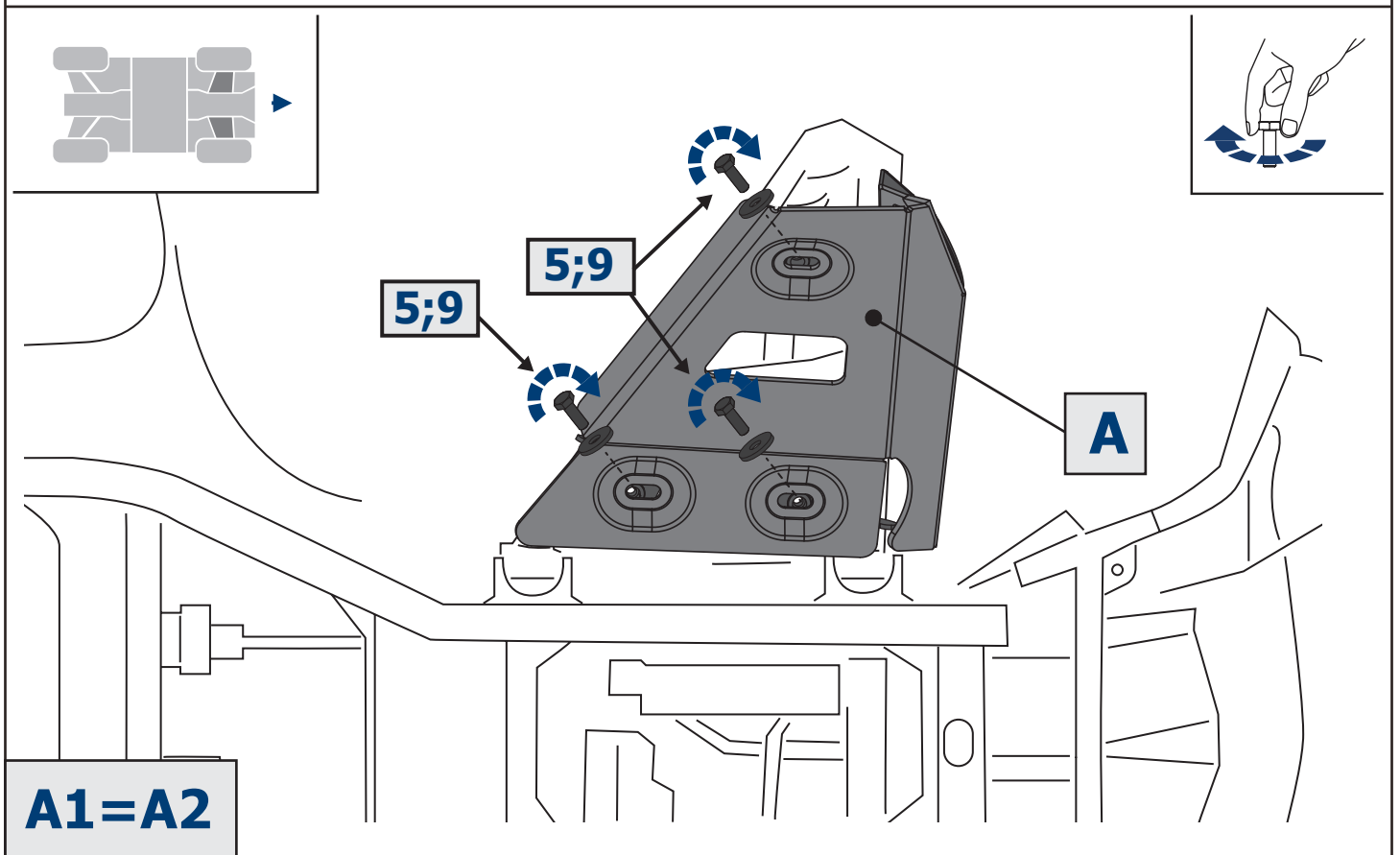
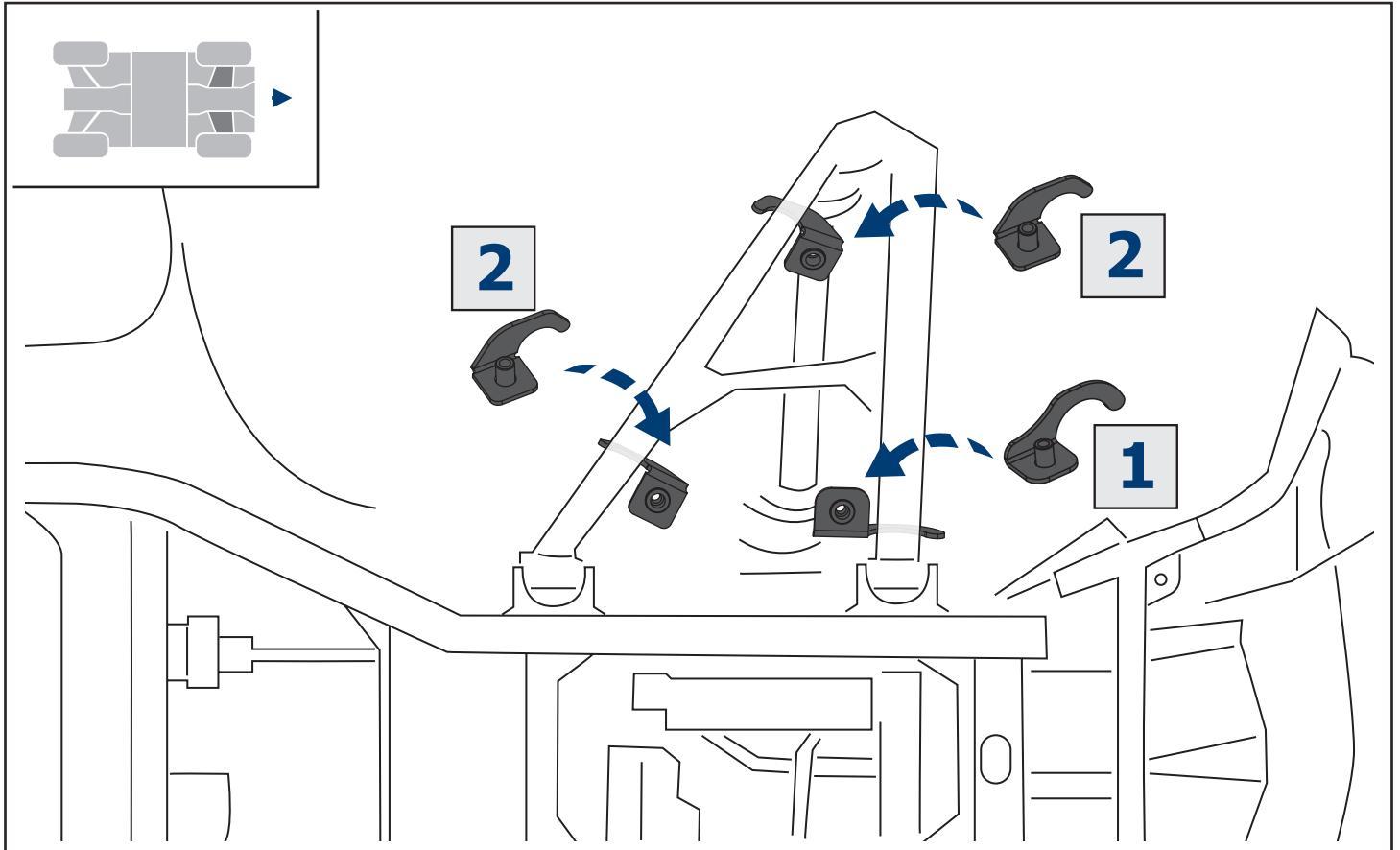

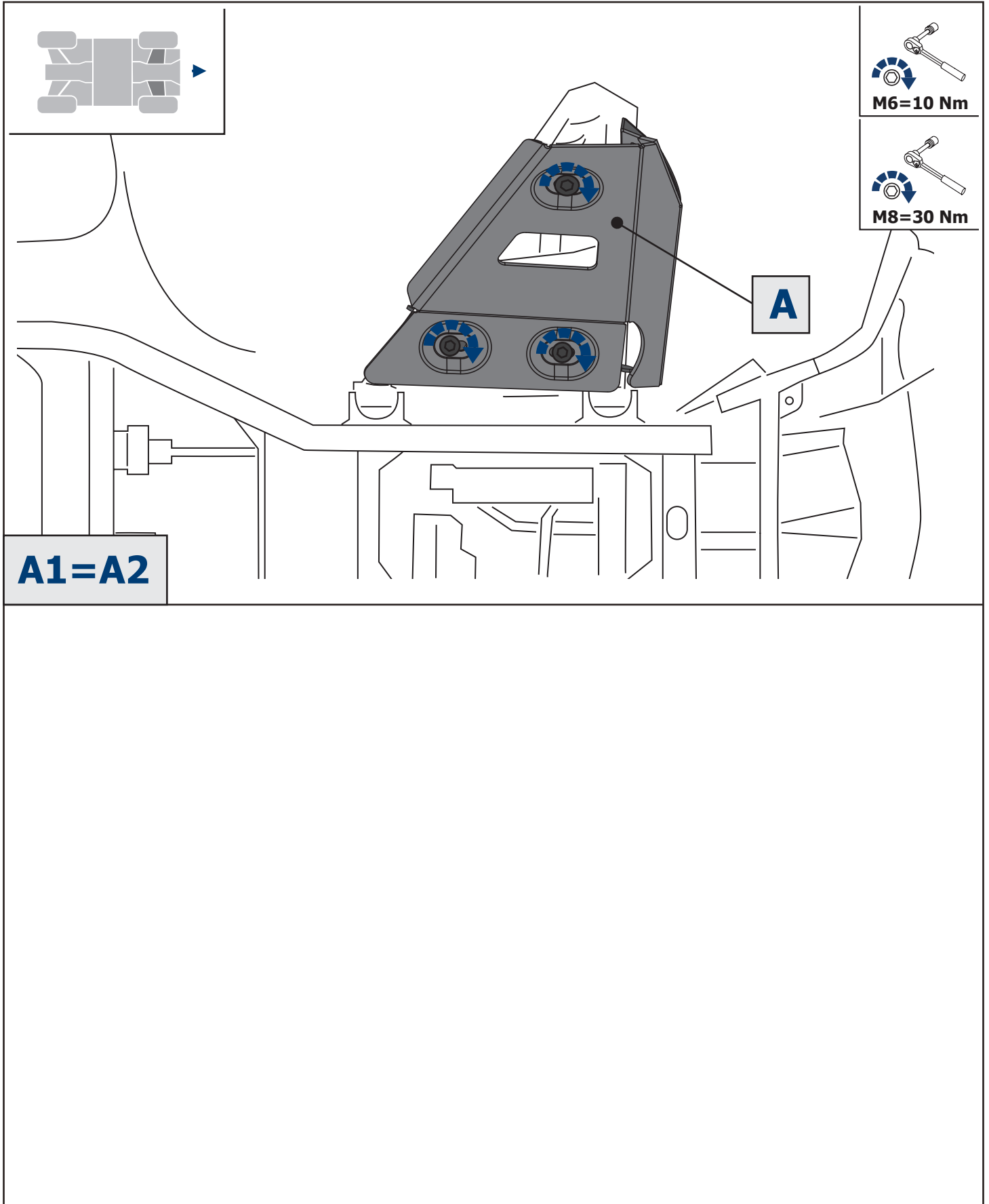

A1=A2

M6=10 Nm

M8=30 Nm

A