

EN FOOTWELL PROTECTION INSTALLATION MANUAL

DE MONTAGEEINLEITUNG FÜR UNTERBODENSCHUTZSYSTEM

RU ИНСТРУКЦИЯ ПО УСТАНОВКЕ КОМПЛЕКТА ЗАЩИТ



For: CForce UForce 1000 EPS (2019-)

2444.6898.1;
444.6898.1





EN Regular fasteners
DE Originale montageteile
RU Штатный крепеж

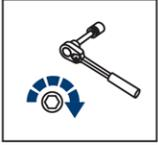

EN Regular fasteners
DE Originale montageteile
RU Штатный крепеж



EN Screw a several turns
DE Für wenigen Umdrehungen befestigen
RU Вкрутить на несколько оборотов



EN Loosen bolts
DE Bolzen lockern
RU Выкрутить на несколько оборотов

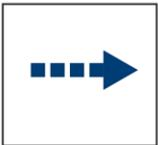

EN Movement Arrow
DE Bewegungsrichtung
RU Движение

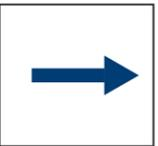

EN Location/Position Arrow
DE Anordnung/Positionsrichtung
RU Расположение



EN Screw Arrow
DE Drehungsrichtung
RU Поворот



EN Drill
DE Bohrer
RU Дрель



Ø6 mm



EN Ratchet
DE Ratsche
RU Трещётка



S - 10;
S - 13



TORX



EN Office Knife
DE Büromesser
RU Канцелярский нож

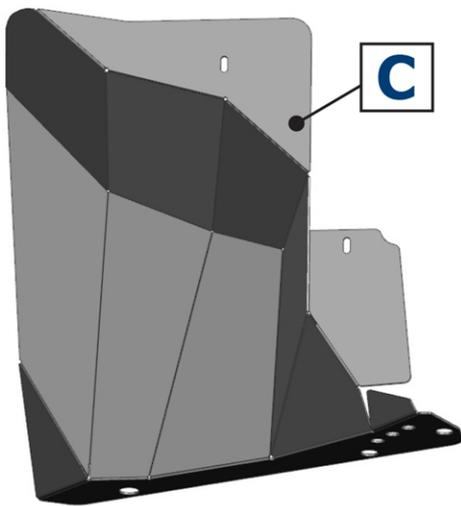

C

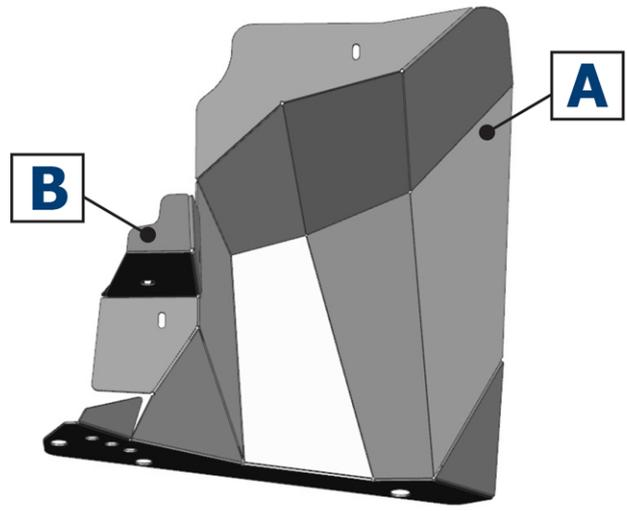

A

B

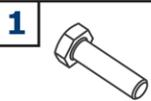

1
M6x25 x4

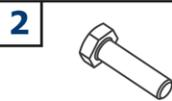

2
M8x25 x2

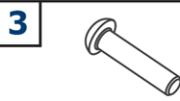

3
M8x25 x6



4
Ø8 x12



5
Ø6 x4

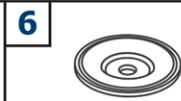

6
Ø8 x2



7
M8 x6

