

EN SKID PLATE INSTALLATION MANUAL

DE MONTAGEEINLEITUNG FÜR UNTERBODENSCHUTZSYSTEM



For: Suzuki Kingquad 500, 750 AXi (2019-)

2444.5515.1



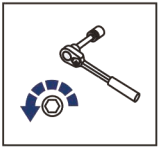

EN Regular fasteners
DE Originale montageile

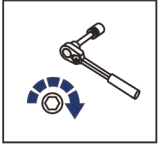

EN Regular fasteners
DE Originale montageile



EN Screw a several turns
DE Für wenigen Umdrehungen befestigen

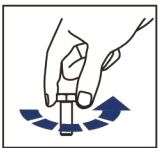

EN Loosen bolts
DE Bolzen lockern

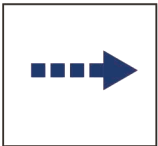

EN Movement Arrow
DE Bewegungsrichtung

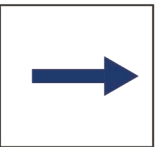



EN Location/Position Arrow
DE Anordnung/Positionsrichtung

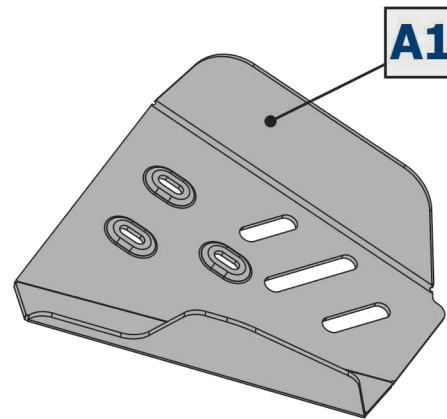
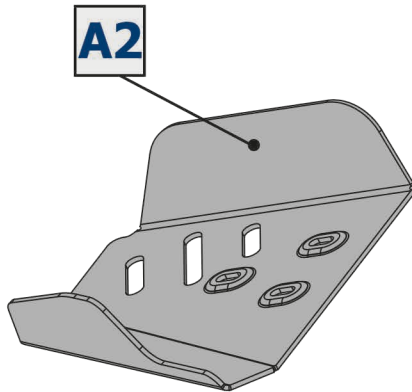

EN Screw Arrow
DE Drehungsrichtung

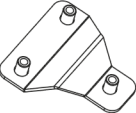

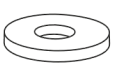
1		x2	2		x6	3		x6
			M8x25		Ø8			

