

EN

SKID PLATE INSTALLATION MANUAL

DE

MONTAGEEINLEITUNG FÜR UNTERBODENSCHUTZSYSTEM



**For: Honda Pioneer 500 (2021-2022)**

2444.2159.2



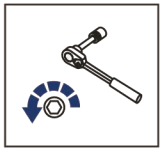

EN Regular fasteners  
DE Originale montageteile

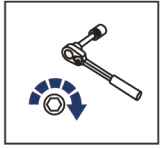

EN Regular fasteners  
DE Originale montageteile



EN Screw a several turns  
DE Für wenigen Umdrehungen befestigen



EN Loosen bolts  
DE Bolzen lockern

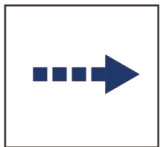

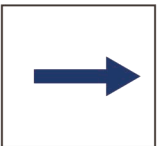

EN Movement Arrow  
DE Bewegungsrichtung



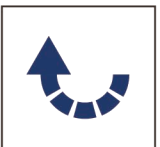





EN Location/Position Arrow  
DE Anordnung/Positionsrichtung

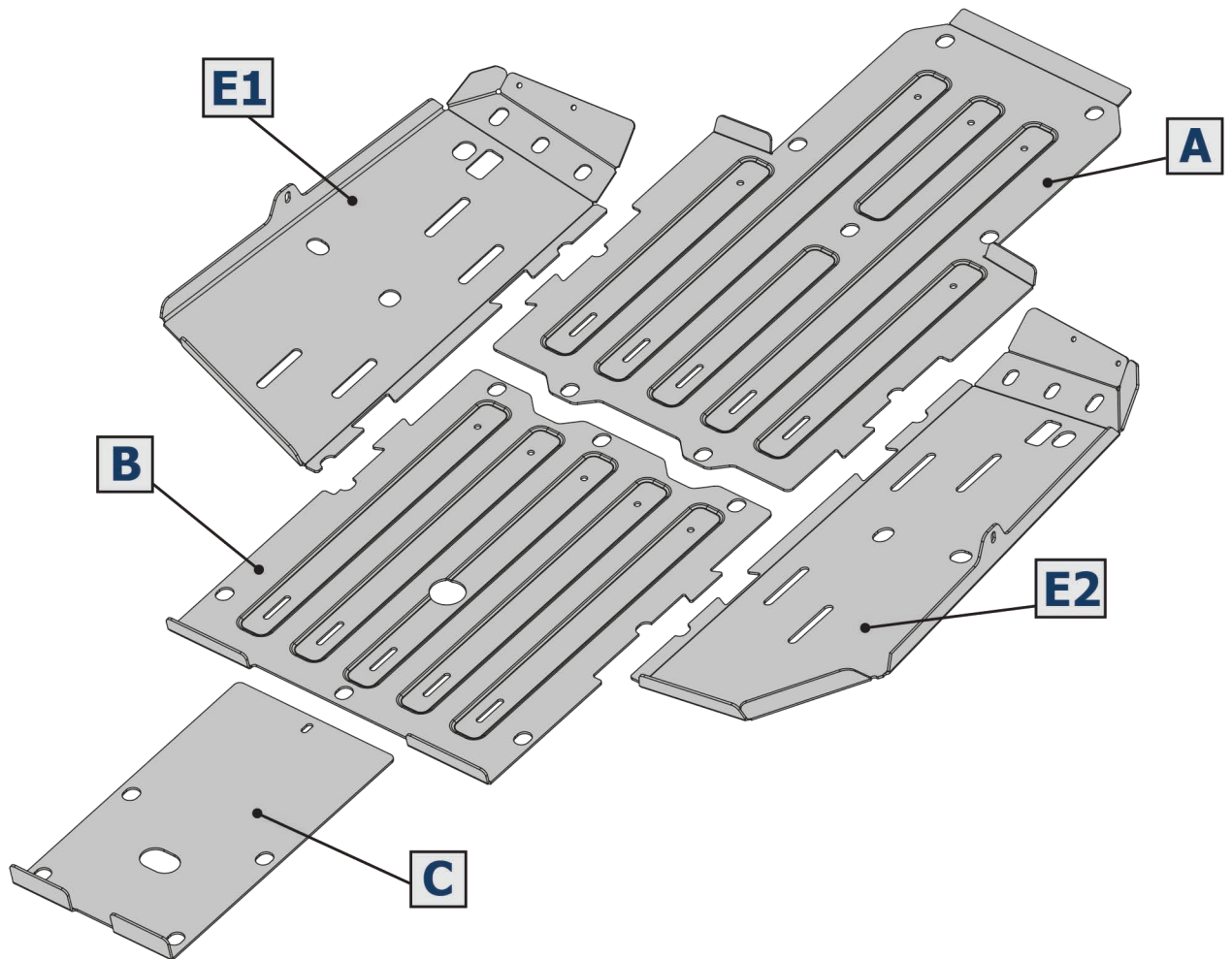

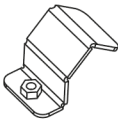
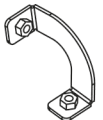
EN Screw Arrow  
DE Drehungsrichtung

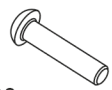
	EN Ratchet DE Ratsche		S - 10; S - 13		HEX S - 6
---	--------------------------	---	-------------------	--	--------------

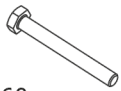

<b>1</b>		x2	<b>2</b>		x2	<b>3</b>		M6x20	x21	<b>4</b>		M8x25	x4	<b>5</b>		M8x20	x2	<b>6</b>		Ø8	x2
<b>7</b>		Ø6	x25	<b>8</b>		Ø8	x4	<b>9</b>		M6x40	x2	<b>10</b>		M6x60	x2						

