

EN SKID PLATE INSTALLATION MANUAL

DE MONTAGEEINLEITUNG FÜR UNTERBODENSCHUTZSYSTEM



For: Honda Pioneer 500 (2013-2020)

2444.2159.1



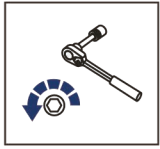

EN Regular fasteners
DE Originale montageteile

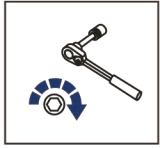

EN Regular fasteners
DE Originale montageteile



EN Screw a several turns
DE Für wenigen Umdrehungen befestigen



EN Loosen bolts
DE Bolzen lockern

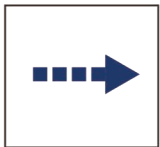

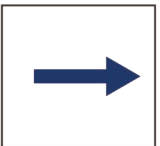

EN Movement Arrow
DE Bewegungsrichtung









EN Location/Position Arrow
DE Anordnung/Positionsrichtung

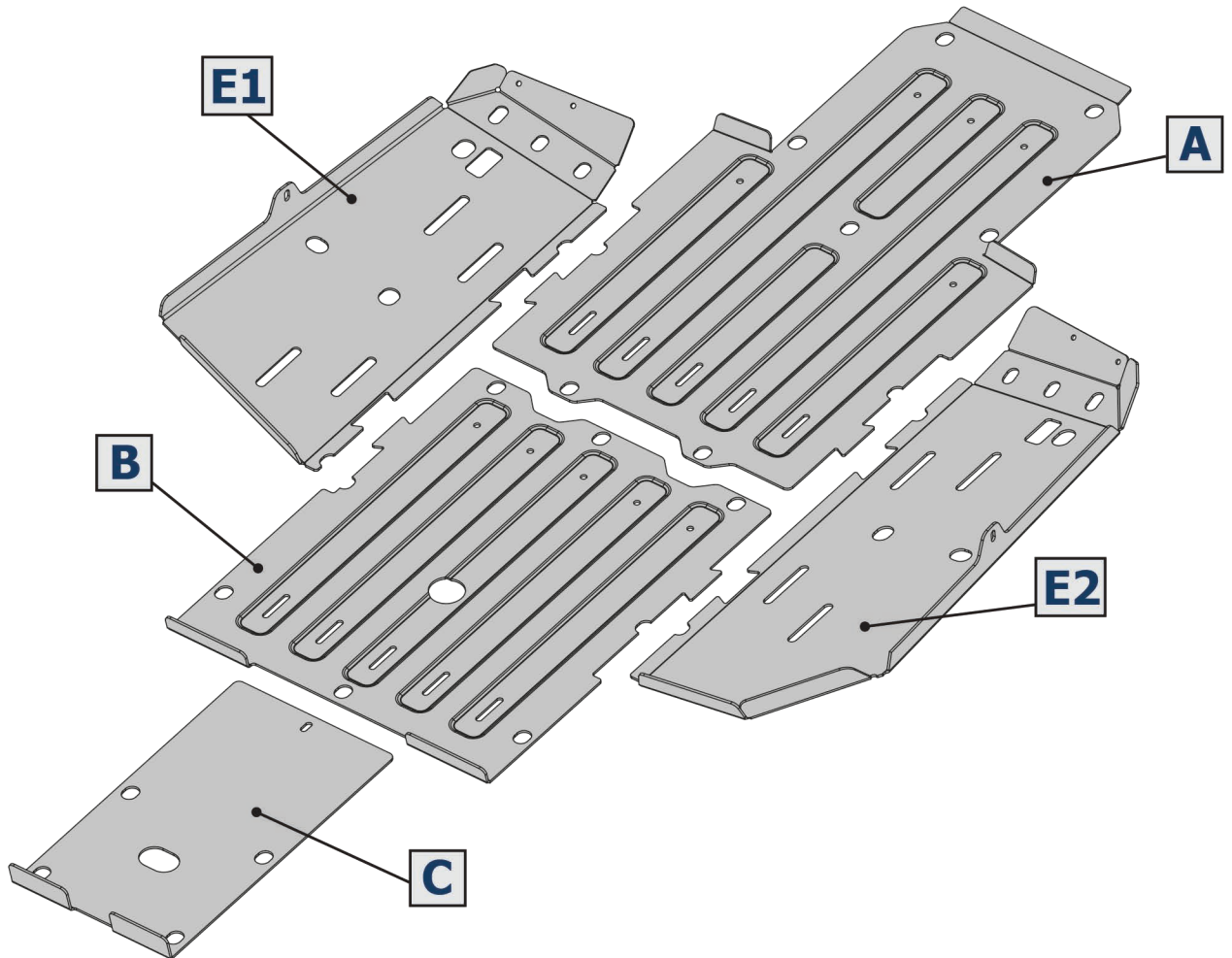

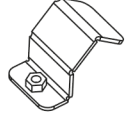
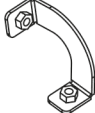
EN Screw Arrow
DE Drehungsrichtung

 <p>EN Ratchet DE Ratsche</p>	 <p>S - 10; S - 13</p>	 <p>S - 6</p>
--	---	---



<p>1</p>  <p>x2</p>	<p>2</p>  <p>x2</p>	<p>3</p>  <p>M6x20 x21</p>	<p>4</p>  <p>M8x25 x4</p>	<p>5</p>  <p>M8x20 x2</p>	<p>6</p>  <p>Ø8 x2</p>
<p>7</p>  <p>Ø6 x21</p>	<p>8</p>  <p>Ø8 x4</p>				

