

EN SKID PLATE INSTALLATION MANUAL

DE MONTAGEEINLEITUNG FÜR UNTERBODENSCHUTZSYSTEM



For: Honda Pioneer 1000 (2022-)

2444.2150.2



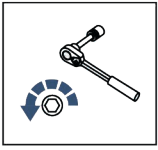

EN Regular fasteners
DE Normale Befestigung

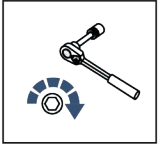

EN Regular fasteners
DE Normale Befestigung

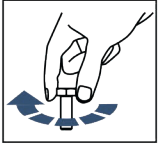

EN Screw a several turns
DE Mit wenigen Umdrehungen befestigen

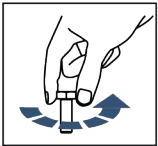

EN Loosen bolts
DE Bolzen lockern

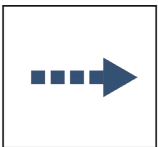

EN Movement Arrow
DE Bewegungsrichtung

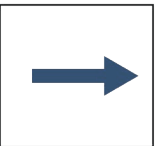







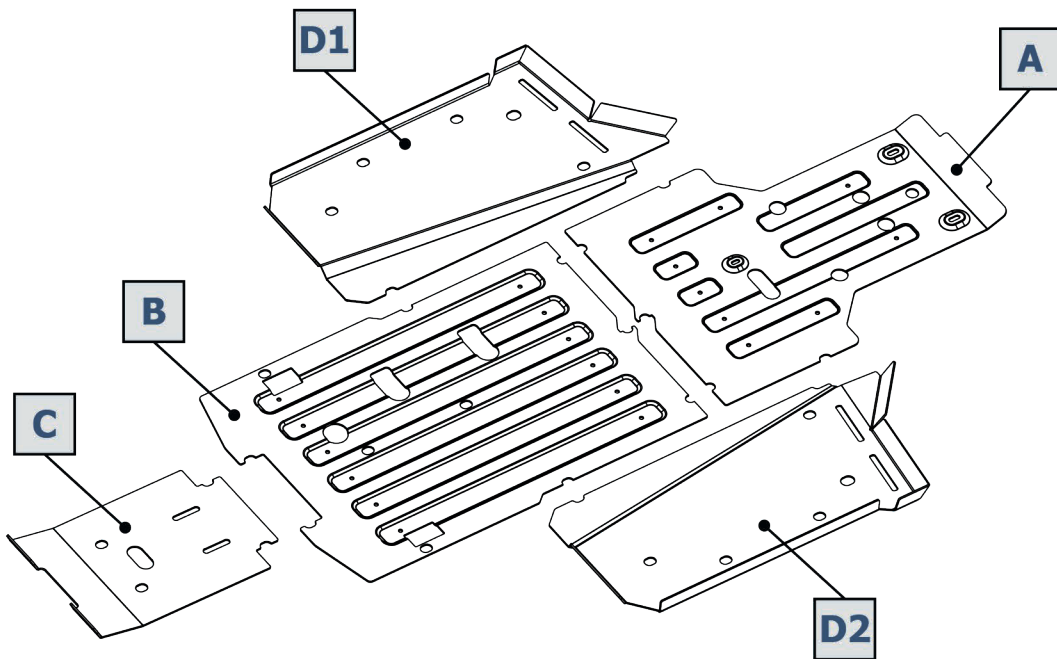
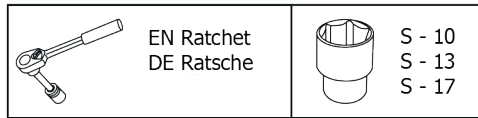

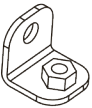

EN Location / Position Arrow
DE Anordnung / Positionsrichtung



EN Screw Arrow
DE Drehrichtung



1  x2	2  x1	3  M6x35 x1	4  M6x20 x23	5  M8x25 x2	6  M10x1.25x25 x2
7  ø8 x2	8  ø6 x1	9  ø10 x2	10  ø6 x23		

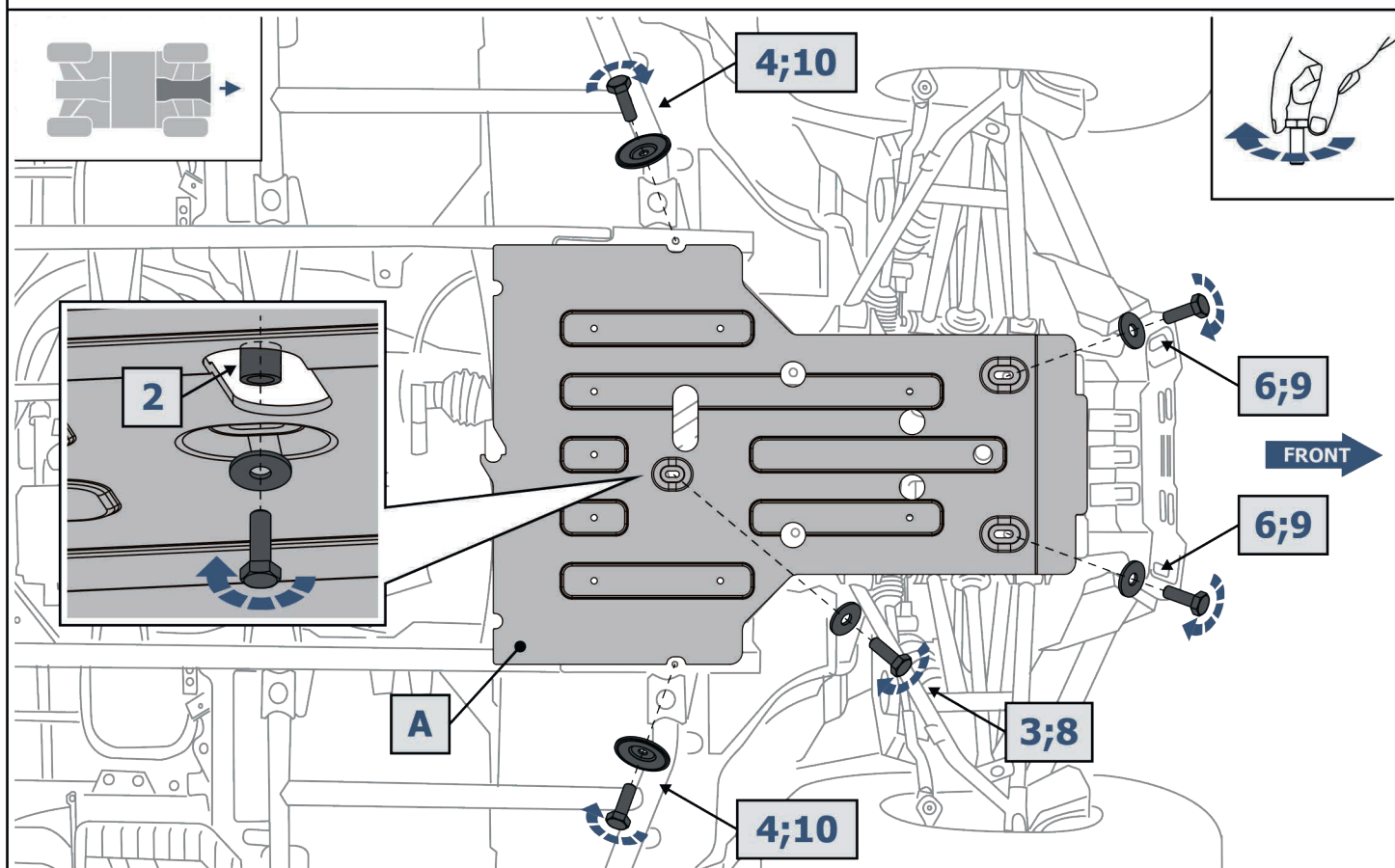
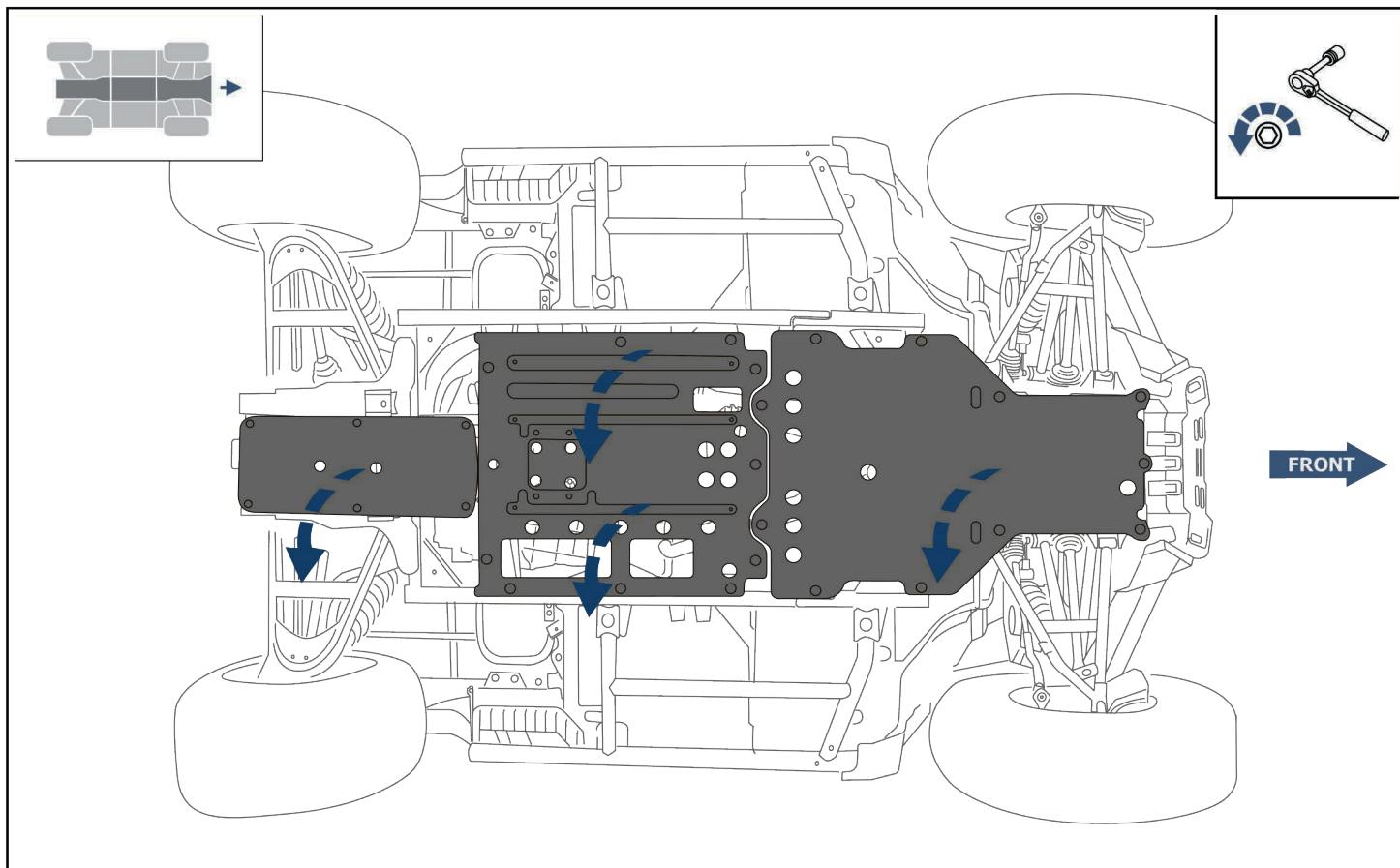

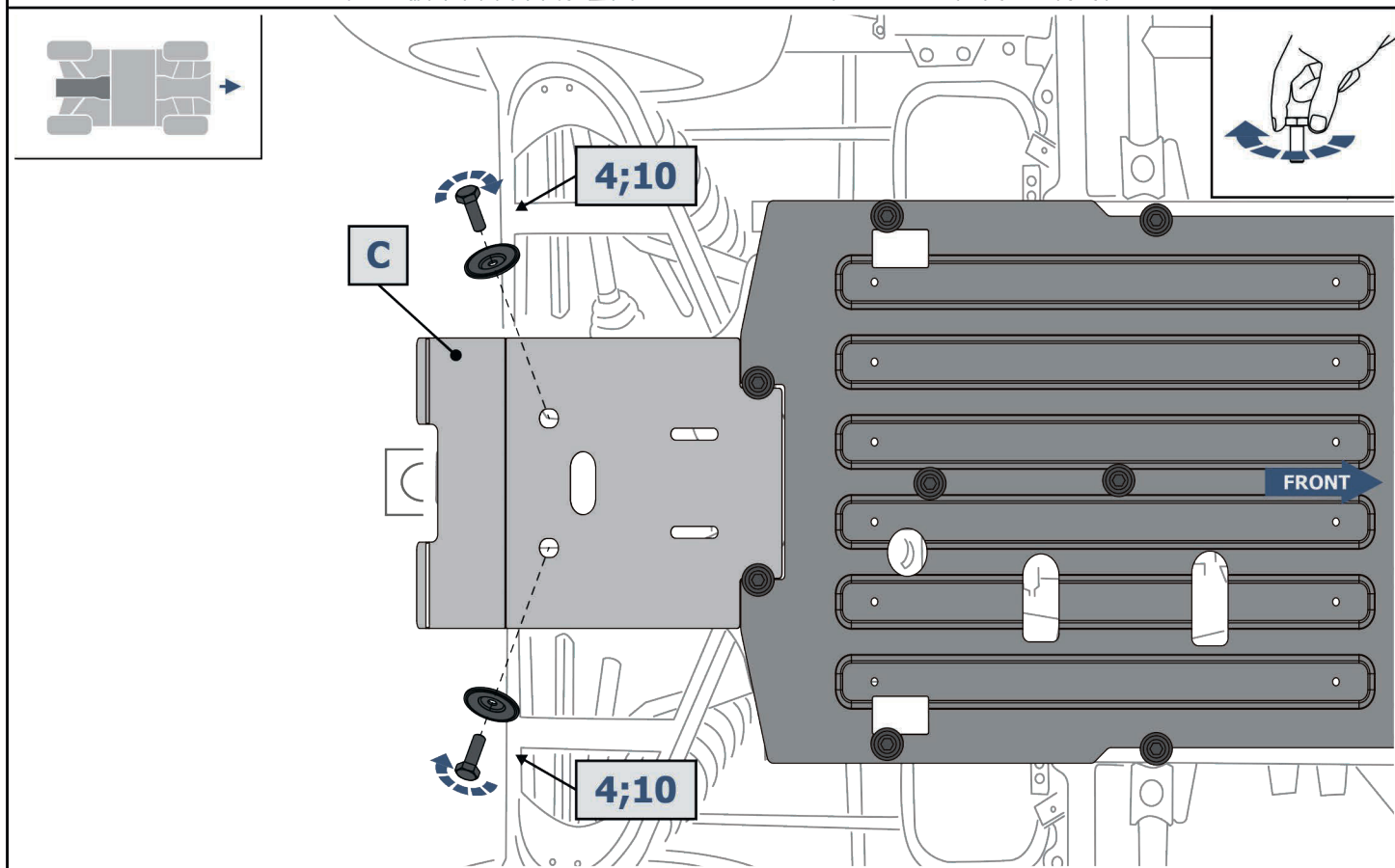
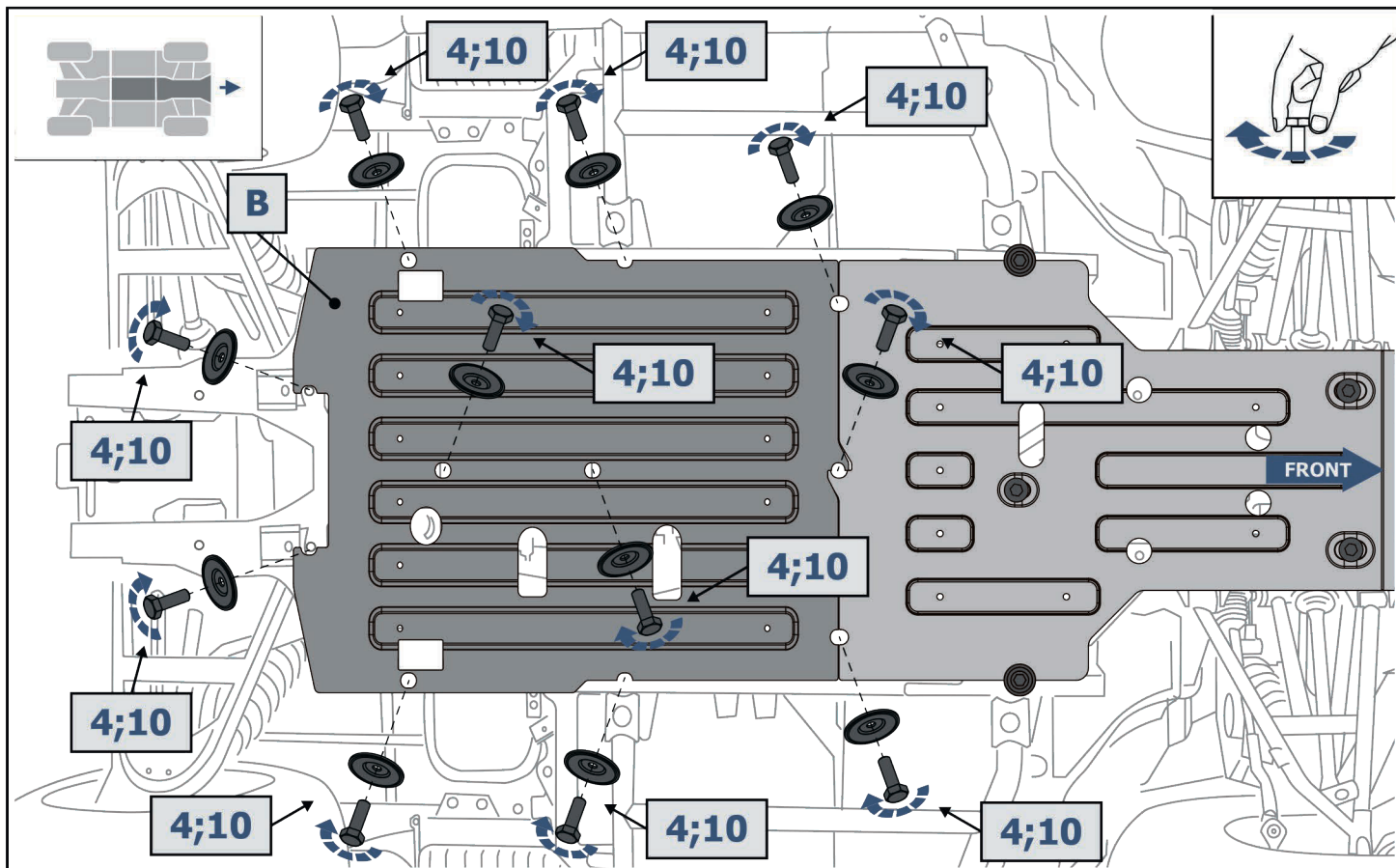

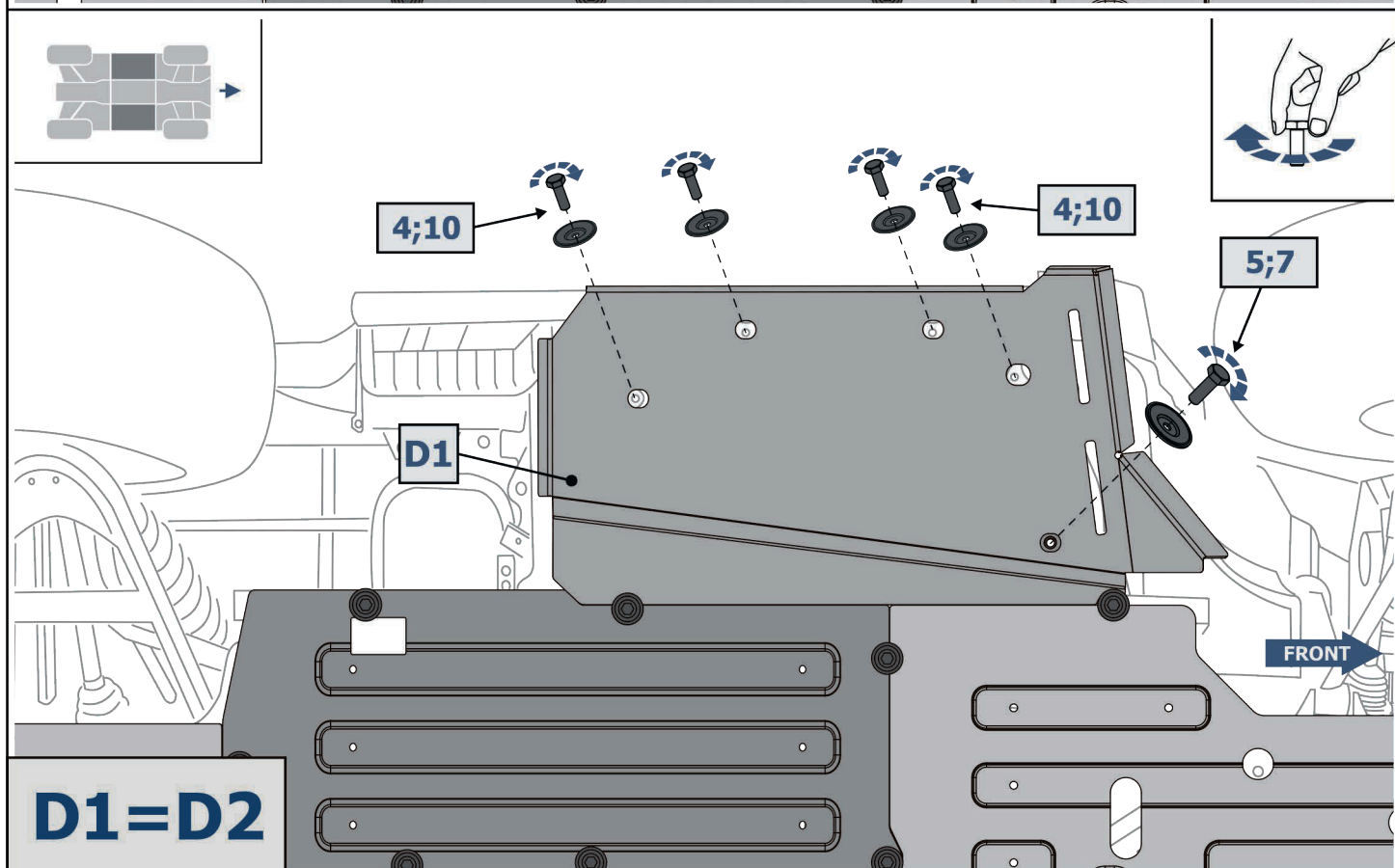
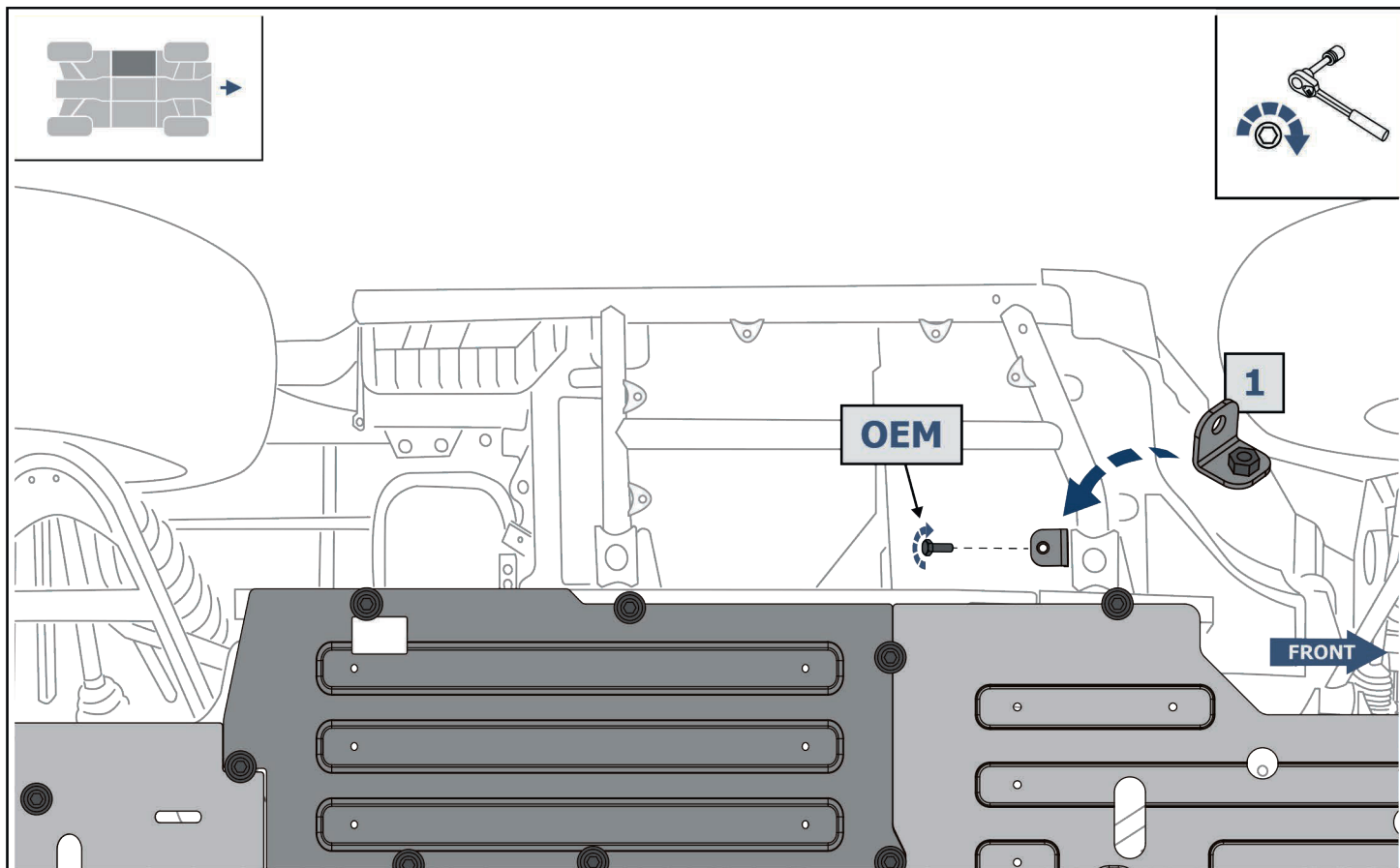

D1=D2

