

EN **SKID PLATE INSTALLATION MANUAL**

DE **MONTAGEEINLEITUNG FÜR UNTERBODENSCHUTZSYSTEM**



For: Yamaha Kodiak 700 (2016-)

24.7132.1-4



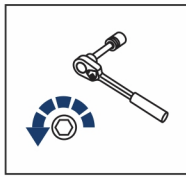

EN Regular fasteners
DE Schraube herausdrehen

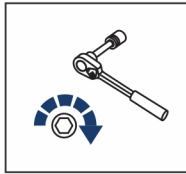

EN Regular fasteners
DE Schraube eindrehen und festziehen

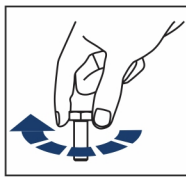

EN Screw a several turns
DE Schraube wenige Umdrehungen eindrehen



EN Loosen bolts
DE Schraube wenige Umdrehungen lösen

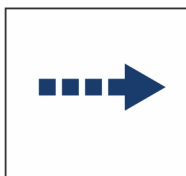

EN Movement Arrow
DE Bewegungsrichtung

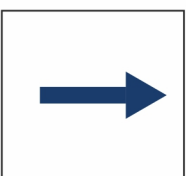







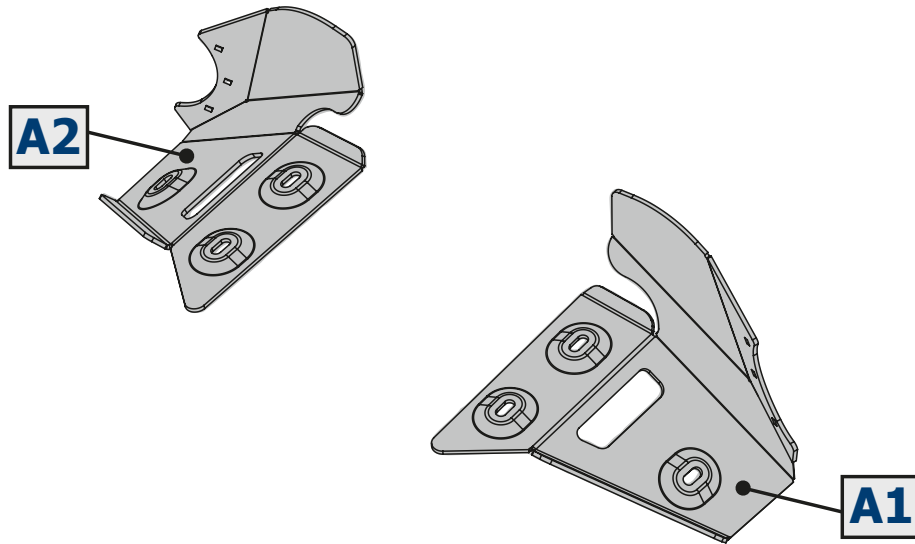
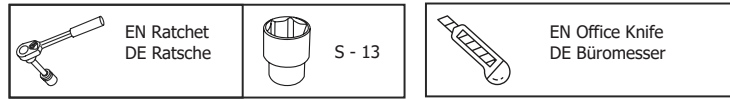

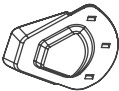
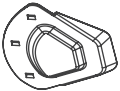
EN Location/Position Arrow
DE Blickrichtung / Postionsrichtung

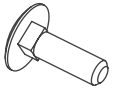

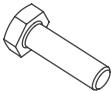
EN Screw Arrow
DE Drehrichtung



1  x1	2  x1	3  x2	4  x4	5  x6	6  Ø6 x6
7  M8x25 x6	8  M6 x6	9  Ø6 x6	10  Ø8 x6		

SCREW FORCE:
M6 - 10 Nm; M8 - 30 Nm

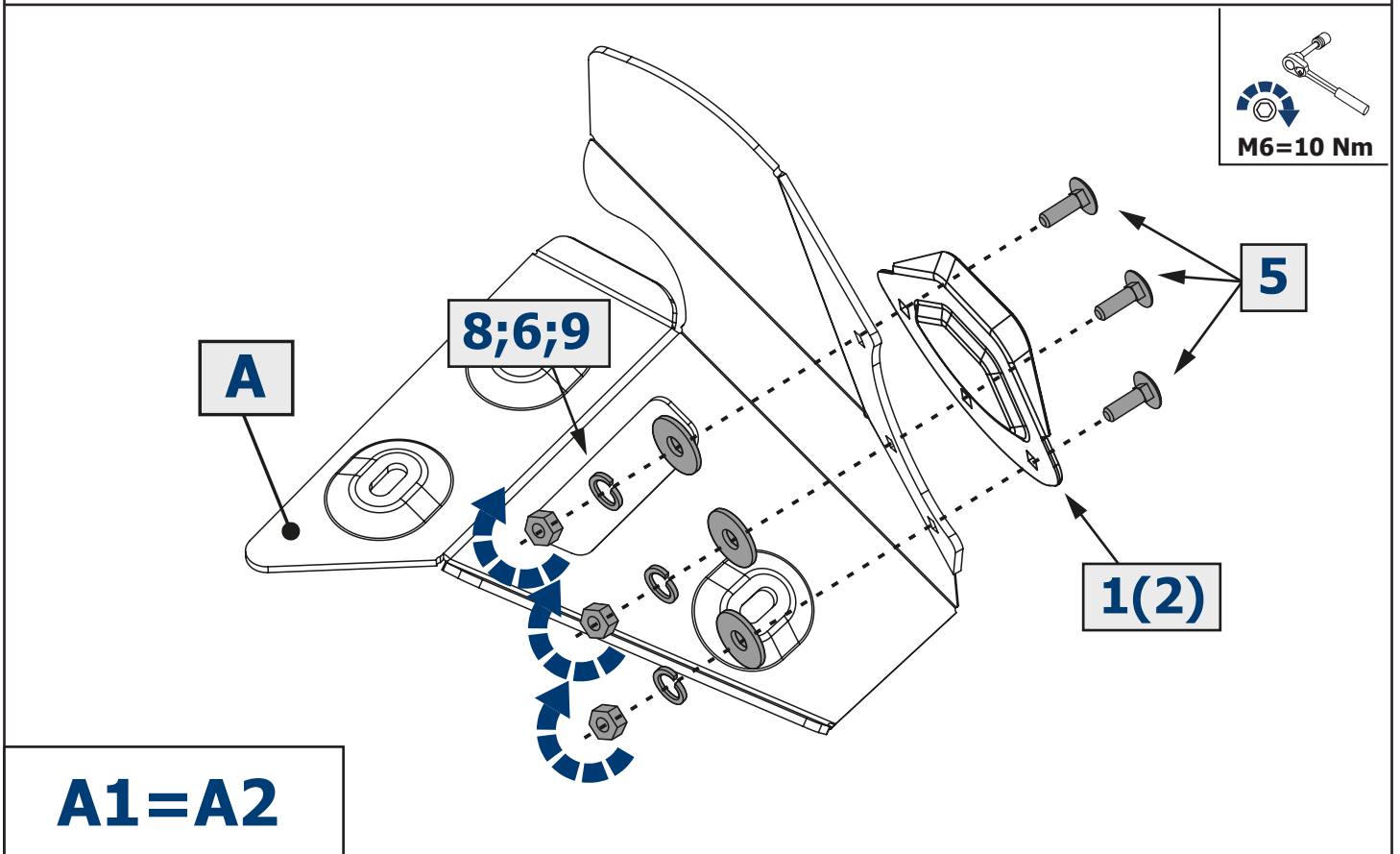
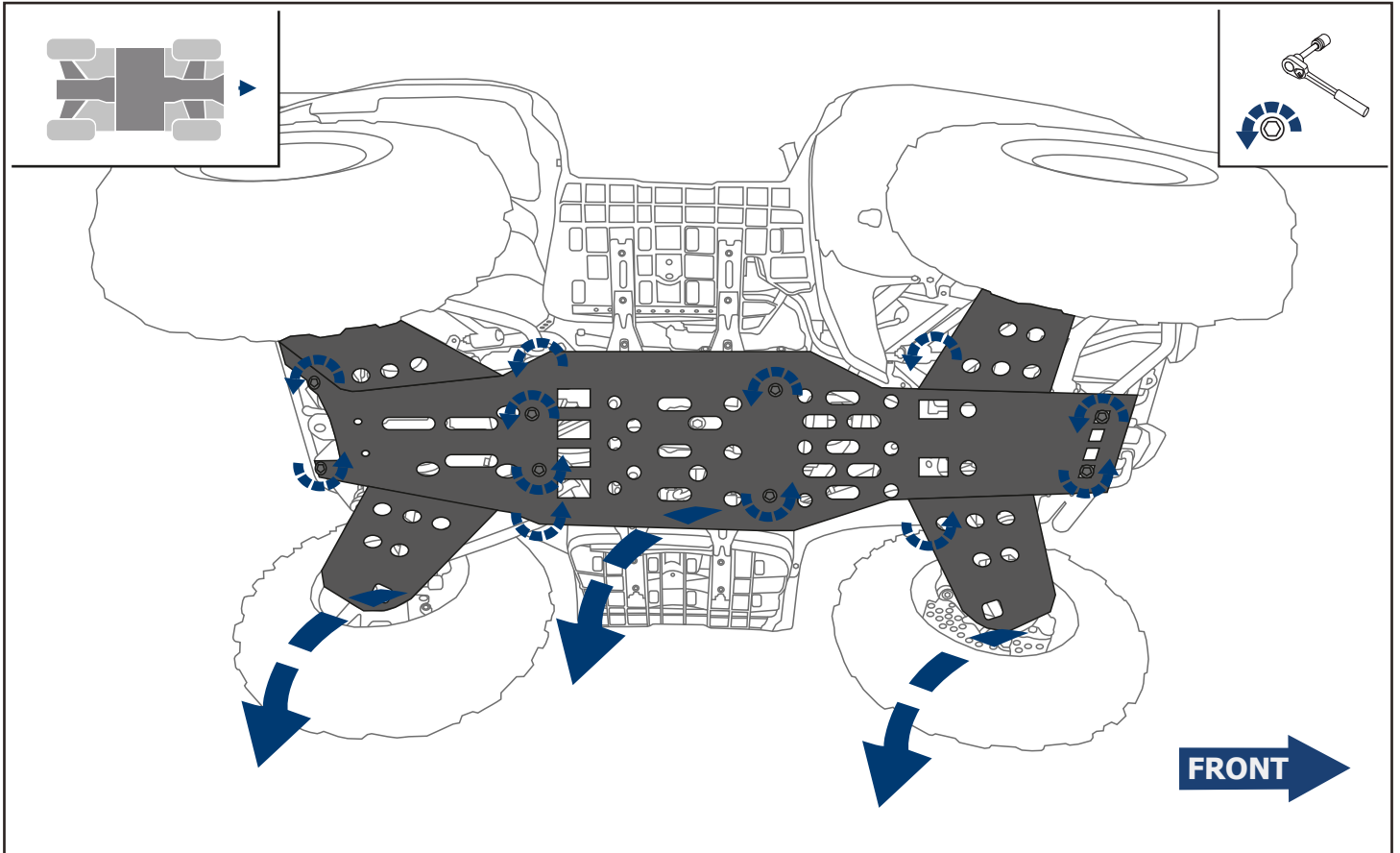

A1=A2

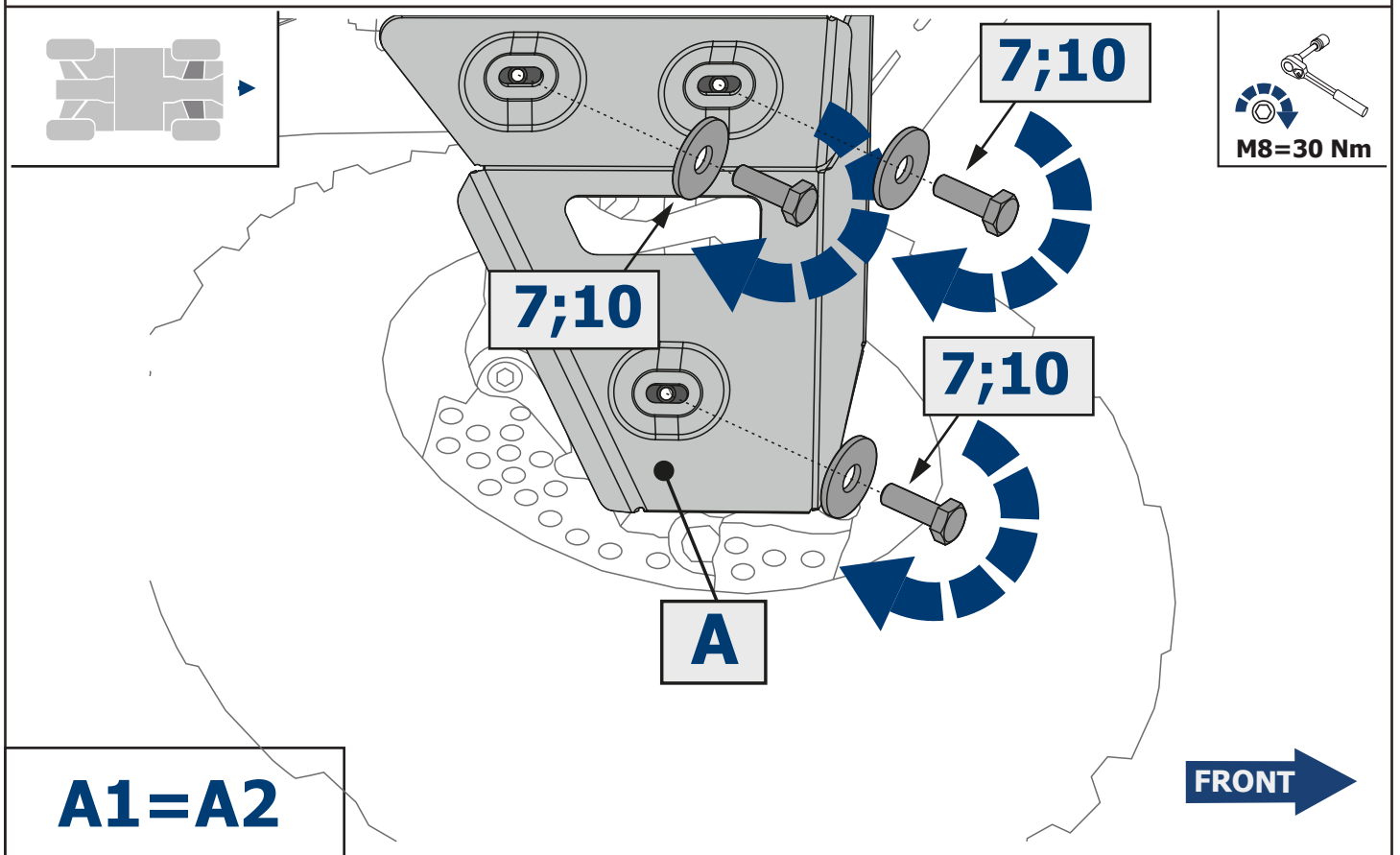
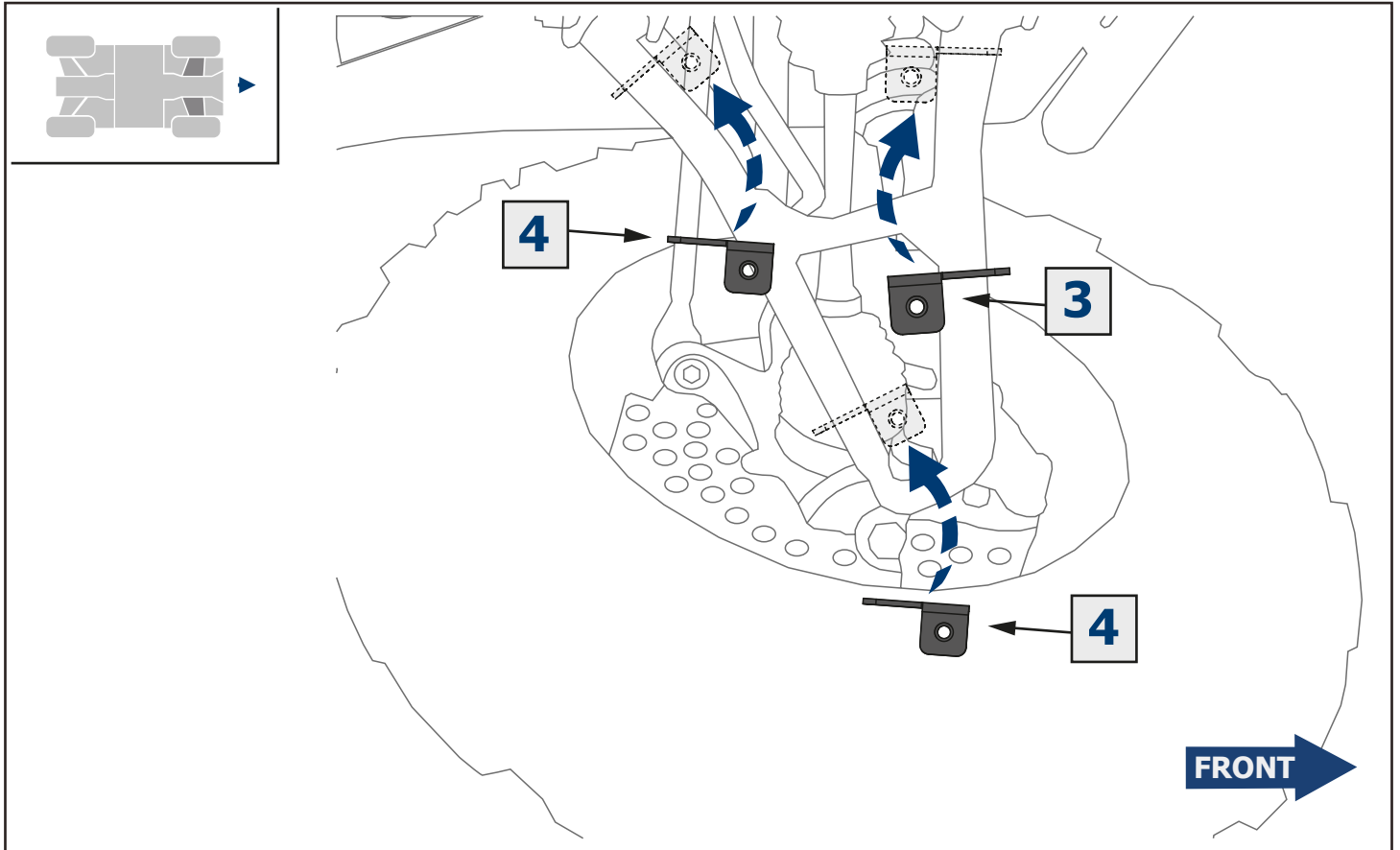

A1=A2