

EN SKID PLATE INSTALLATION MANUAL

DE MONTAGEEINLEITUNG FÜR UNTERBODENSCHUTZSYSTEM



For: TRX 420/500 FA/FE/FM IRS (2015 -)

2444.2110.1-5

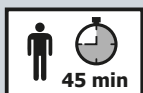

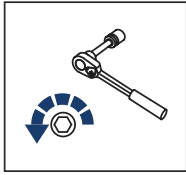

EN Regular fasteners
DE Schraube herausdrehen

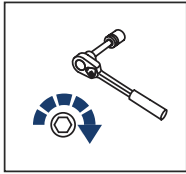

EN Regular fasteners
DE Schraube eindrehen und festziehen

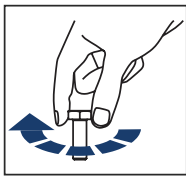

EN Screw a several turns
DE Schraube wenige Umdrehungen eindrehen

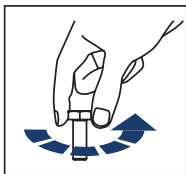

EN Loosen bolts
DE Schraube wenige Umdrehungen lösen

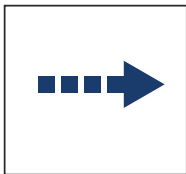

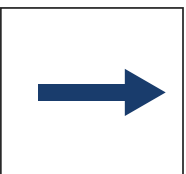

EN Movement Arrow
DE Bewegungsrichtung



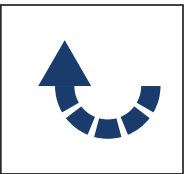



EN Location/Position Arrow
DE Blickrichtung / Postionsrichtung

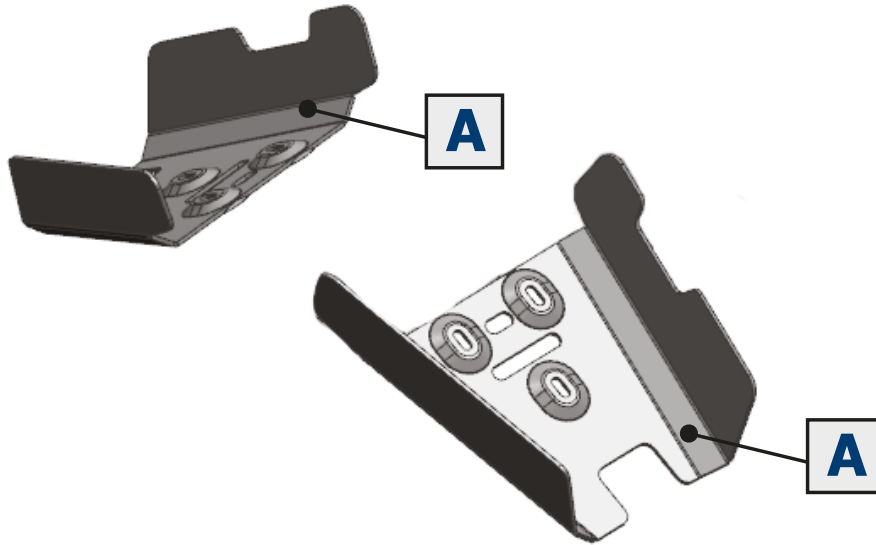

EN Screw Arrow
DE Drehrichtung

 <p>EN Ratchet DE Ratsche</p>	 <p>S - 10; S - 13</p>	 <p>EN Office Knife DE Büromesser</p>
--	---	--

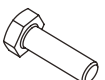

<p>1</p>  <p>x4</p>	<p>2</p>  <p>M6x20</p> <p>x2</p>	<p>3</p>  <p>M8x25</p> <p>x4</p>	<p>4</p>  <p>ø6</p> <p>x2</p>	<p>5</p>  <p>ø8</p> <p>x4</p>
---	--	--	---	---

SCREW FORCE:
M6 - 10 Nm; M8 - 30 Nm

